

CPDFR5V0R-HF

RoHS Device
Halogen Free

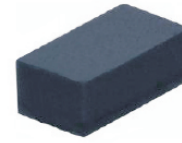

Features

- Bi-directional ESD protection.
- IEC61000-4-2(ESD); ±30kV(contact)
- Surface mount package.
- Operating voltage: 5V

Mechanical data

- Case: 1005/SOD-323F standard package, molded plastic.
- Terminals: Gold plated, solderable per MIL-STD-750,method 2026
- Mounting position: Any
- Weight: 0.006 grams(approx.).

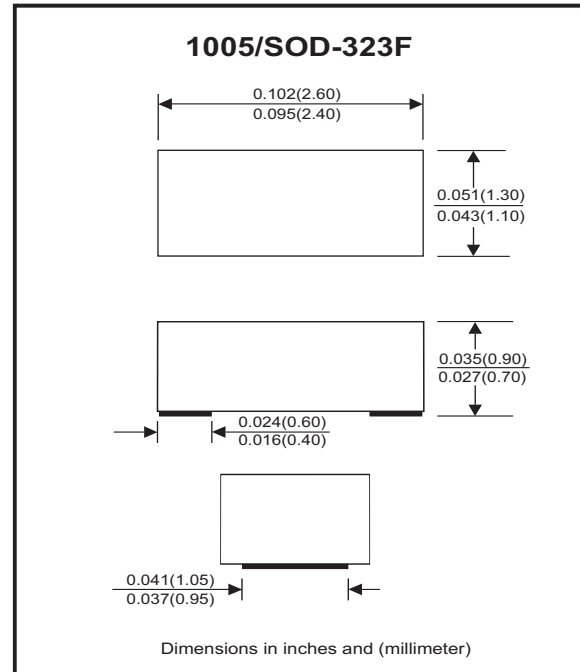

Circuit Diagram



Maximum Rating (at TA=25°C unless otherwise noted)

Parameter	Conditions	Symbol	Value	Unit
Peak pulse power	T _P = 8/20us	P _{PP}	150	W
Peak pulse current	T _P = 8/20us	I _{PP}	11	A
ESD capability	IEC 61000-4-2(air)	ESD	±30	kV
	IEC 61000-4-2(contact)	ESD	±30	
Operation temperature range		T _J	-40~+150	°C
Storage temperature range		T _{STG}	-40~+150	°C

Electrical Characteristics (at TA=25°C unless otherwise noted)

Parameter	Conditions	Symbol	Min	Typ	Max	Unit
Working peak reverse voltage		V _{RWM}			5	V
Diode breakdown voltage	I _T = 1mA	V _{BR}	5.6		9.4	V
Reverse current	V _{RWM} = 5V	I _R		5	90	nA
Clamping voltage	I _{PP} = 1A, T _P = 8/20us	V _C			8	V
	I _{PP} = 11A, T _P = 8/20us	V _C			14	V
Junction capacitance	V _R = 0V, f = 1MHz	C _J		20	30	pF

RATING AND CHARACTERISTIC CURVES (CPDFR5V0R-HF)

Fig. 1 - Reverse Characteristics

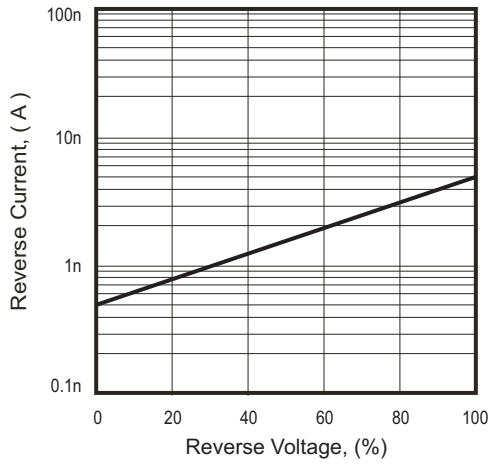

Fig. 2 - Capacitance Between Terminals Characteristics

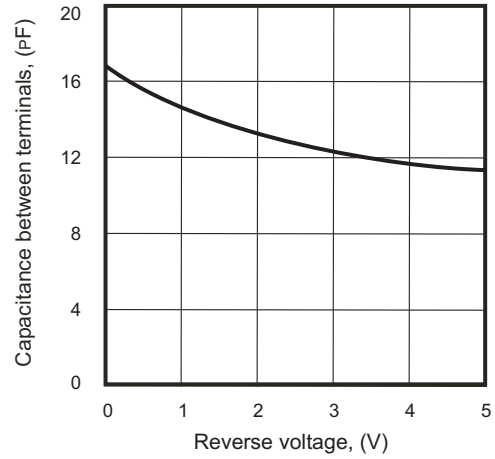

Fig.3 - Clamping Voltage Vs. Peak Pulse Current

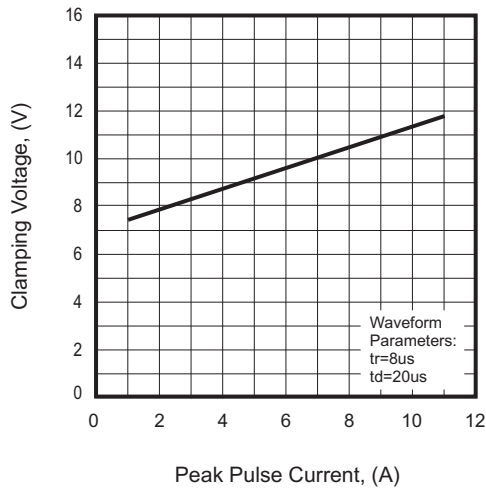
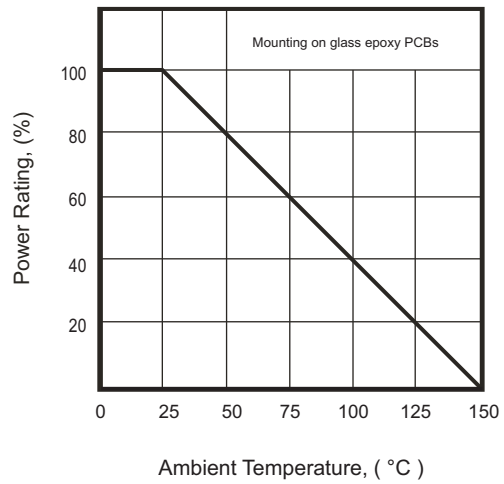
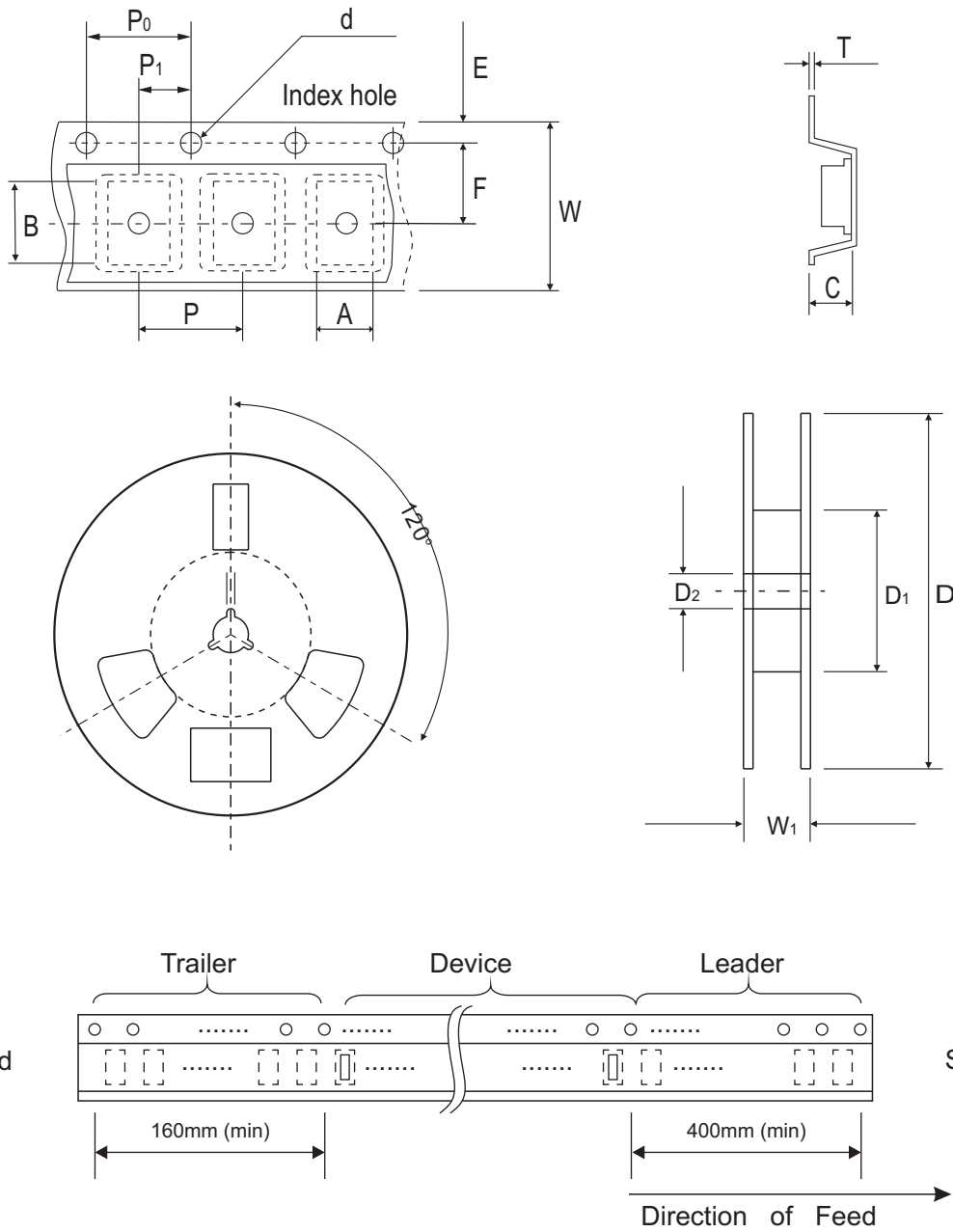

Fig. 4 - Power Rating Derating Curve



Reel Taping Specification



1005 (SOD-323F)	SYMBOL	A	B	C	d	D	D ₁	D ₂
	(mm)	1.45 ± 0.05	2.80 ± 0.05	1.00 ± 0.05	1.50 +0.10 -0	178.00 ± 1.00	60.0 ± 0.50	13.50 ± 0.20
	(inch)	0.057 ± 0.002	0.110 ± 0.002	0.039 ± 0.002	0.059 +0.004 -0	7.008 ± 0.039	2.362 ± 0.020	0.531 ± 0.008

1005 (SOD-323F)	SYMBOL	E	F	P	P ₀	P ₁	T	W	W ₁
	(mm)	1.75 ± 0.10	3.50 ± 0.05	4.00 ± 0.10	4.00 ± 0.10	2.00 ± 0.05	0.23 ± 0.05	8.00 ± 0.10	12.00 +0.50 -0
	(inch)	0.069 ± 0.004	0.138 ± 0.002	0.157 ± 0.004	0.157 ± 0.004	0.079 ± 0.002	0.009 ± 0.002	0.315 ± 0.004	0.472 +0.020 -0

Marking Code

Part Number	Marking Code
CPDFR5V0P-HF	E5R

E5R

Suggested PAD Layout

SIZE	1005/SOD-323F	
	(mm)	(inch)
A	2.00	0.079
B	0.70	0.028
C	1.30	0.051
D	2.70	0.106
E	1.30	0.051

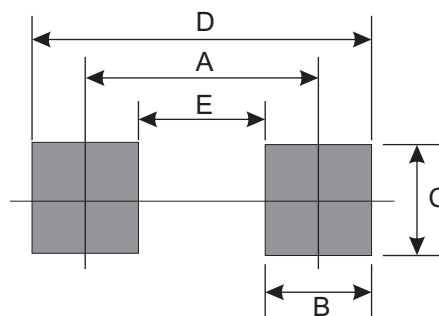

Standard Packaging

Case Type	Qty Per Reel	Reel Size
	(Pcs)	(inch)
1005/SOD-323F	4,000	7