

## Diode

Fast Switching Emitter Controlled Diode

## IDV30E60C

FullPAK with Emitter Controlled Diode

Datasheet

Industrial & Multimarket

## Fast Switching Emitter Controlled Diode

### Features:

- Electrically isolated FullPAK for easy assembly
- 600 V Emitter Controlled technology
- Fast recovery
- Soft switching
- Low reverse recovery charge
- Low forward voltage
- Easy paralleling
- Qualified according to JESD-022 for target applications
- Pb-free lead plating; RoHS compliant
- Halogen free (according to IEC 61249-2-21)
- Complete product spectrum and PSpice Models:  
<http://www.infineon.com/diode/>

### Applications:

- Switching diode for PFC applications with operating range up to 30kHz

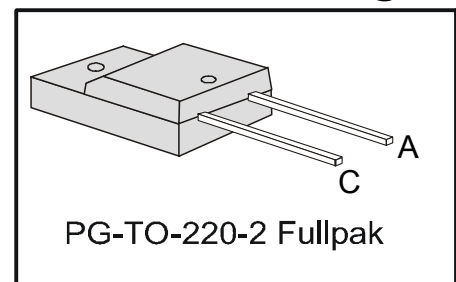
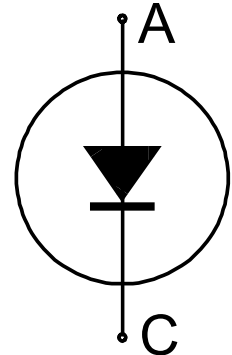

### Key Performance and Package Parameters

Type	$V_{rrm}$	$I_f$	$V_f, T_{vj}=25^\circ\text{C}$	$T_{vjmax}$	Marking	Package
IDV30E60C	600V	30A	1.65V	175°C	D30E60C	PG-TO220-2-22 FP



**Table of Contents**

Description ..... 2

Table of Contents ..... 3

Maximum ratings ..... 4

Thermal Resistance ..... 4

Electrical Characteristics ..... 4

Electrical Characteristics diagrams ..... 6

Package Drawing ..... 9

Testing Conditions ..... 10

Revision History ..... 11

Disclaimer ..... 11

**Emitter Controlled Diode**
**Maximum ratings**

Parameter	Symbol	Value	Unit
Repetitive peak reverse voltage	$V_{RRM}$	600	V
Diode forward current, limited by $T_{vjmax}$ $T_C = 25^\circ\text{C}$ $T_C = 100^\circ\text{C}$	$I_F$	21.0 12.0	A
Diode pulsed current, $I_F$ limited by $T_{vjmax}$	$I_{Fpuls}$	90.0	A
Power dissipation $T_C = 25^\circ\text{C}$	$P_{tot}$	37.0	W
Operating junction temperature	$T_{vj}$	-40...+175	$^\circ\text{C}$
Storage temperature	$T_{stg}$	-55...+150	$^\circ\text{C}$
Soldering temperature, wave soldering 1.6 mm (0.063 in.) from case for 10s		260	$^\circ\text{C}$
Mounting torque, M3 screw Maximum of mounting processes: 3	$M$	0.6	Nm

**Thermal Resistance**

Parameter	Symbol	Conditions	Max. Value	Unit
<b>Characteristic</b>				
Diode thermal resistance, <sup>1)</sup> junction - case	$R_{th(j-c)}$		4.00	K/W
Thermal resistance junction - ambient	$R_{th(j-a)}$		65	K/W

**Electrical Characteristic, at  $T_{vj} = 25^\circ\text{C}$ , unless otherwise specified**

Parameter	Symbol	Conditions	Value			Unit
			min.	typ.	max.	
<b>Static Characteristic</b>						
Diode forward voltage	$V_F$	$I_F = 30.0\text{A}$ $T_{vj} = 25^\circ\text{C}$ $T_{vj} = 175^\circ\text{C}$	- -	1.65 1.65	2.05	V
Reverse leakage current	$I_R$	$V_R = 600\text{V}$ $T_{vj} = 25^\circ\text{C}$ $T_{vj} = 175^\circ\text{C}$	- -	- -	40.0 1000.0	$\mu\text{A}$

**Electrical Characteristic, at  $T_{vj} = 25^\circ\text{C}$ , unless otherwise specified**

Parameter	Symbol	Conditions	Value			Unit
			min.	typ.	max.	
<b>Dynamic Characteristic</b>						
Internal emitter inductance measured 5mm (0.197 in.) from case	$L_E$		-	7.0	-	nH

**Switching Characteristic, Inductive Load, at  $T_{vj} = 25^\circ\text{C}$** 

Parameter	Symbol	Conditions	Value			Unit
			min.	typ.	max.	

<sup>1)</sup> Please be aware that in non standard load conditions, due to high  $R_{th(j-c)}$ ,  $T_{vj}$  close to  $T_{vjmax}$  can be reached.

## Emitter Controlled Diode

 Diode Characteristic, at  $T_{vj} = 25^{\circ}\text{C}$ 

Diode reverse recovery time	$t_{rr}$	$T_{vj} = 25^{\circ}\text{C}$ , $V_R = 400\text{V}$ , $I_F = 30.0\text{A}$ , $dI_F/dt = 1000\text{A}/\mu\text{s}$	-	130	-	ns
Diode reverse recovery charge	$Q_{rr}$		-	0.88	-	$\mu\text{C}$
Diode peak reverse recovery current	$I_{rrm}$		-	16.9	-	A
Diode peak rate of fall of reverse recovery current during $t_b$	$di_{rr}/dt$		-	-598	-	$\text{A}/\mu\text{s}$

 Switching Characteristic, Inductive Load, at  $T_{vj} = 175^{\circ}\text{C}$ 

Parameter	Symbol	Conditions	Value			Unit
			min.	typ.	max.	

 Diode Characteristic, at  $T_{vj} = 175^{\circ}\text{C}$ 

Diode reverse recovery time	$t_{rr}$	$T_{vj} = 175^{\circ}\text{C}$ , $V_R = 400\text{V}$ , $I_F = 30.0\text{A}$ , $dI_F/dt = 1000\text{A}/\mu\text{s}$	-	217	-	ns
Diode reverse recovery charge	$Q_{rr}$		-	2.40	-	$\mu\text{C}$
Diode peak reverse recovery current	$I_{rrm}$		-	22.9	-	A
Diode peak rate of fall of reverse recovery current during $t_b$	$di_{rr}/dt$		-	-307	-	$\text{A}/\mu\text{s}$

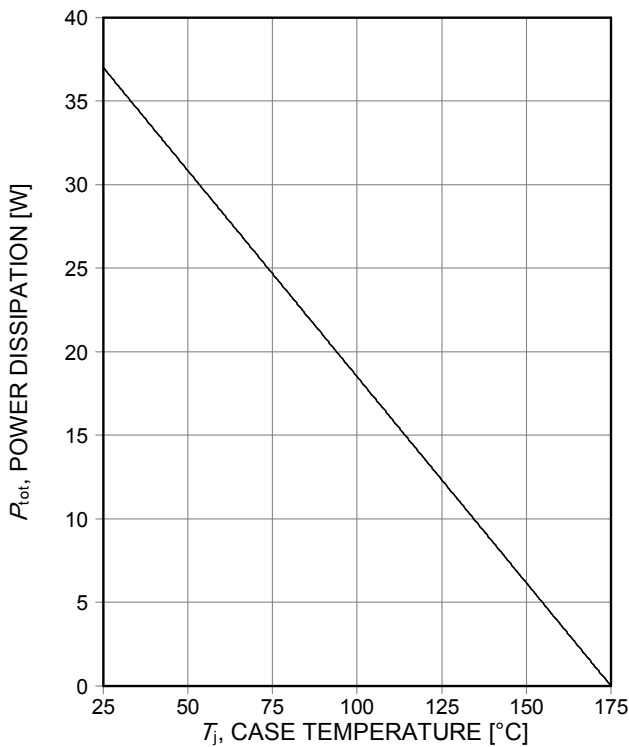

Figure 1. Power dissipation as a function of case temperature ( $T_j \leq 175^\circ\text{C}$ )

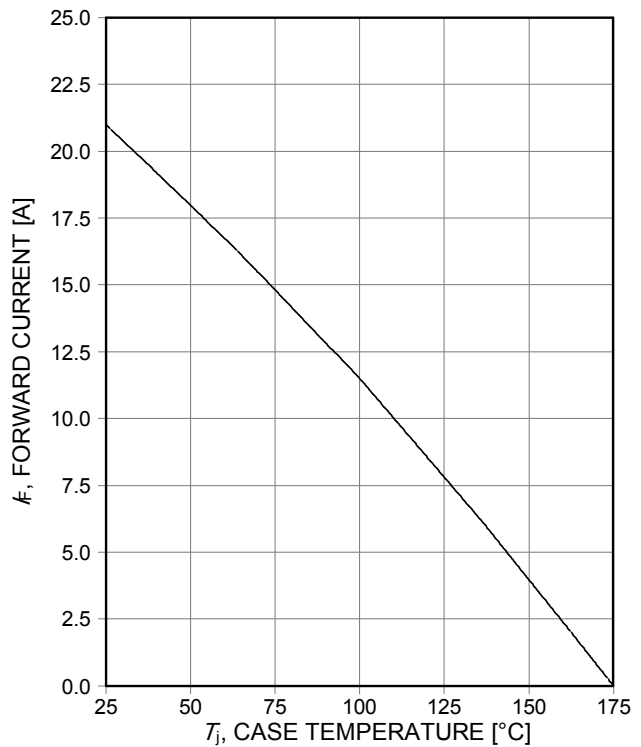

Figure 2. Diode forward current as a function of case temperature ( $V_{GE} \geq 15\text{V}$ ,  $T_j \leq 175^\circ\text{C}$ )

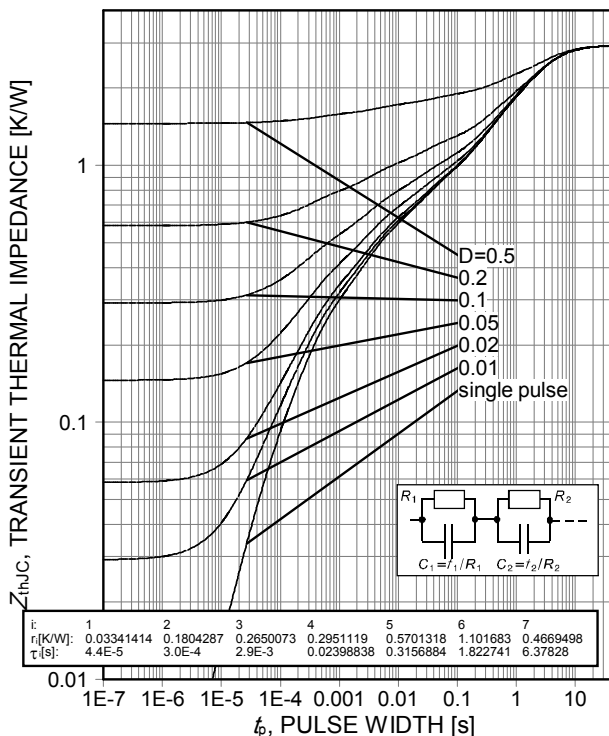

Figure 3. Diode transient thermal impedance as a function of pulse width ( $D = t_p/T$ )

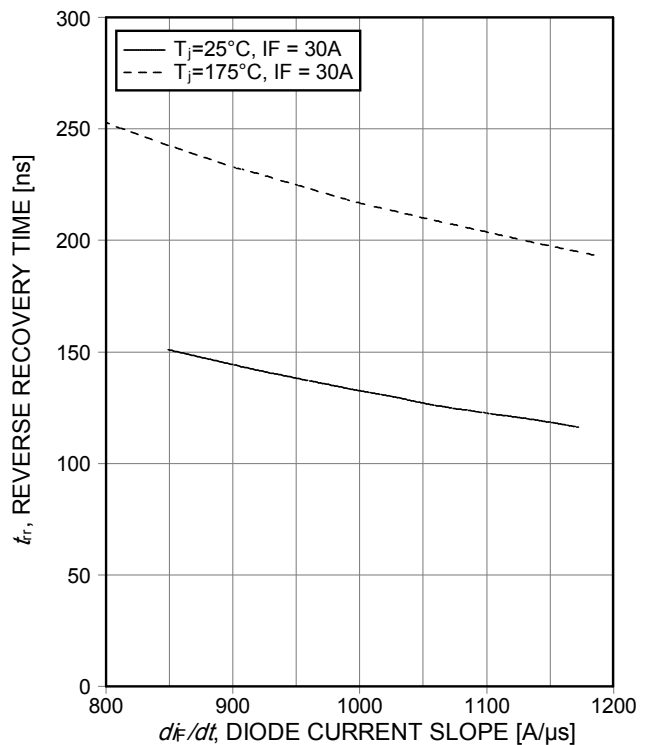
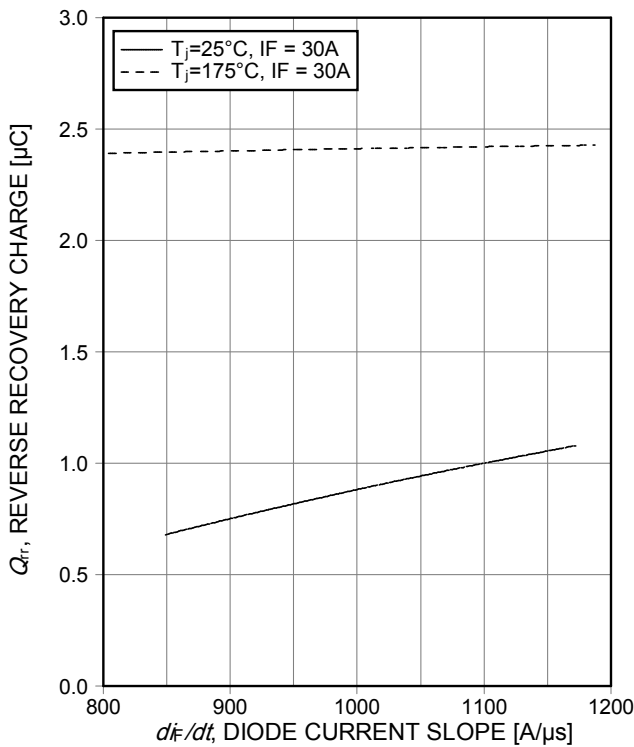
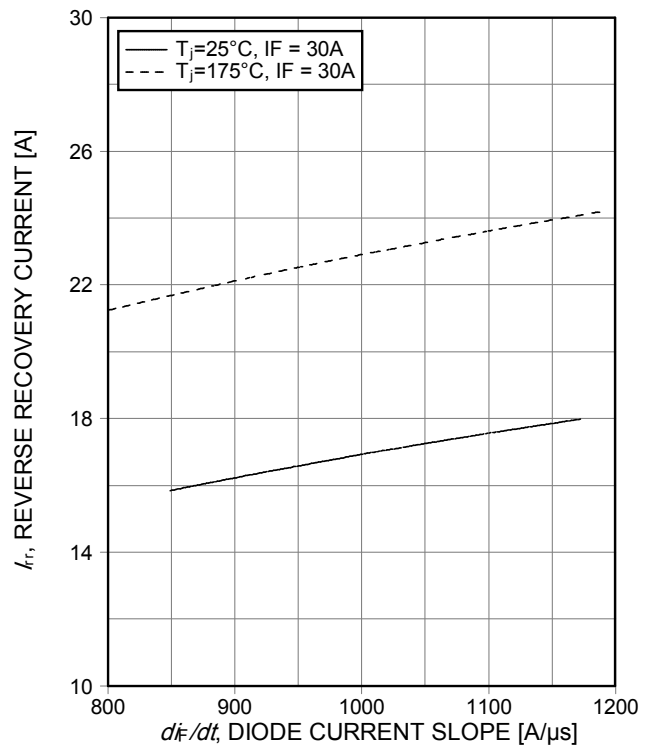

Figure 4. Typical reverse recovery time as a function of diode current slope ( $V_R=400\text{V}$ ,  $I_F=30\text{A}$ , Dynamic test circuit in Figure E)



**Figure 5. Typical reverse recovery charge as a function of diode current slope**  
 ( $V_R=400V$ ,  $I_F=30A$ , Dynamic test circuit in Figure E)



**Figure 6. Typical reverse recovery current as a function of diode current slope**  
 ( $V_R=400V$ ,  $I_F=30A$ , Dynamic test circuit in Figure E)

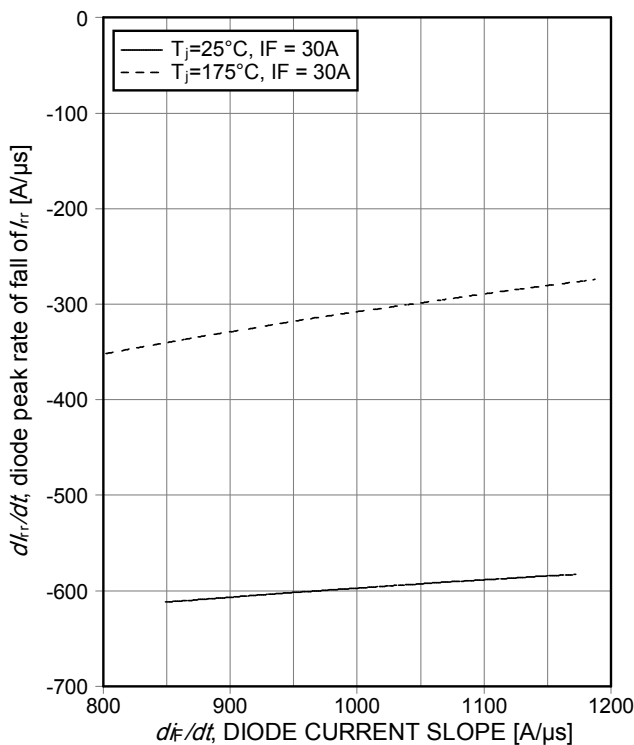

**Figure 7. Typical diode peak rate of fall of reverse recovery current as a function of diode current slope**  
 ( $V_R=400V$ ,  $I_F=30A$ , Dynamic test circuit in Figure E)

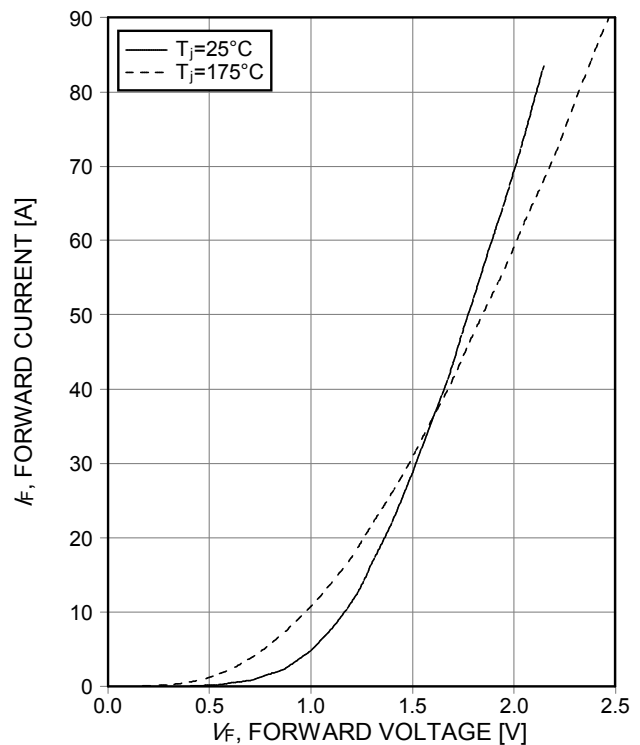

**Figure 8. Typical diode forward current as a function of forward voltage**

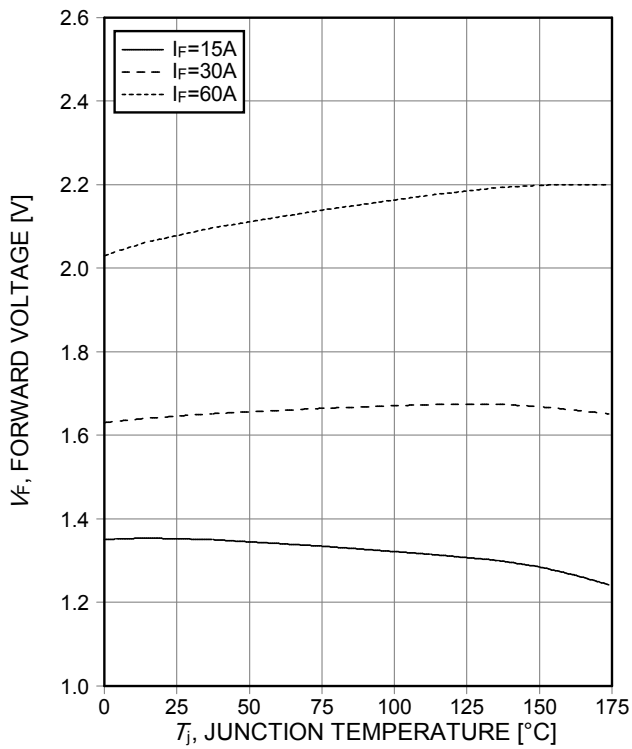
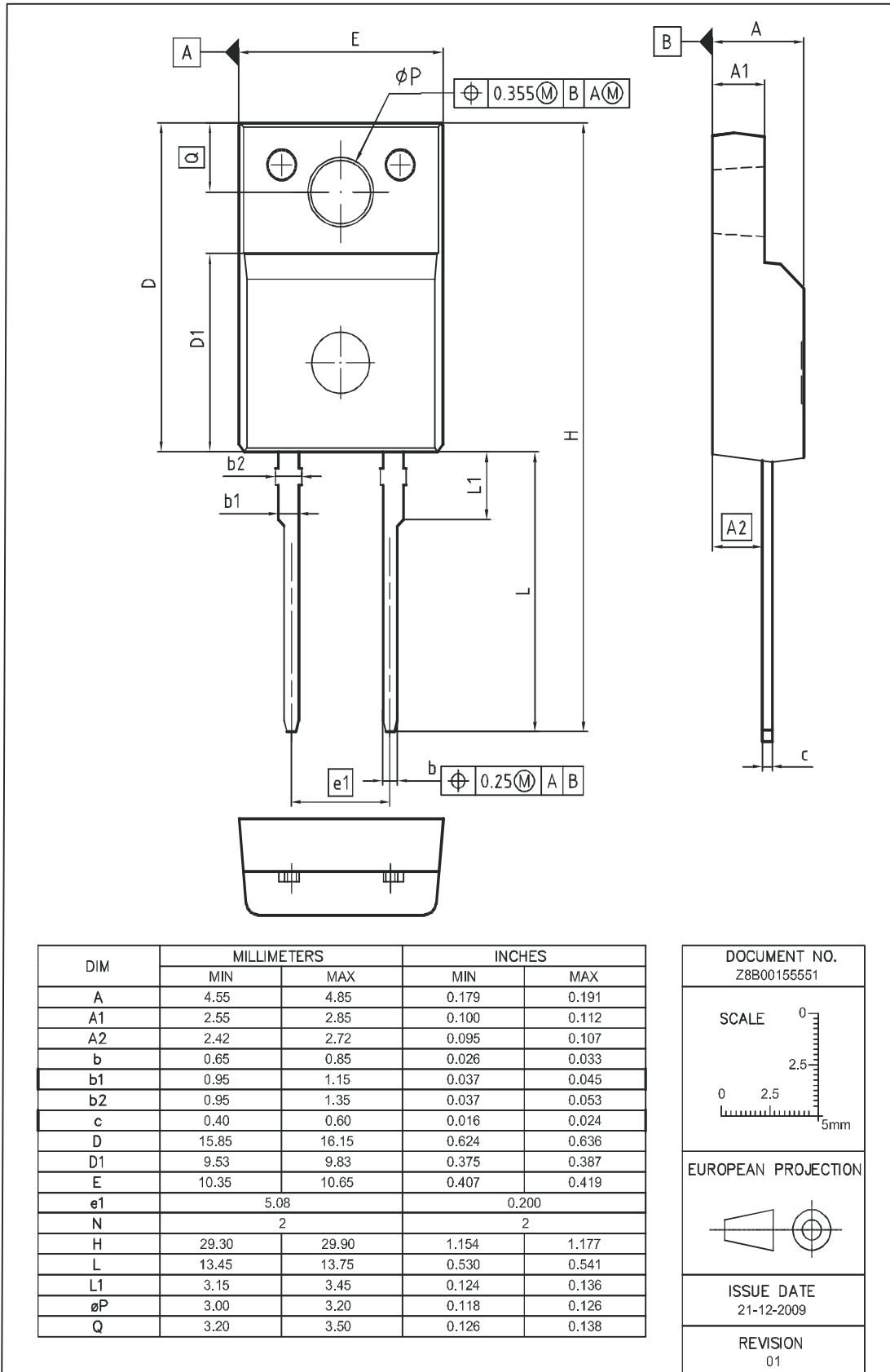

Figure 9. Typical diode forward voltage as a function of junction temperature



PG-TO220-2-22



Emitter Controlled Diode

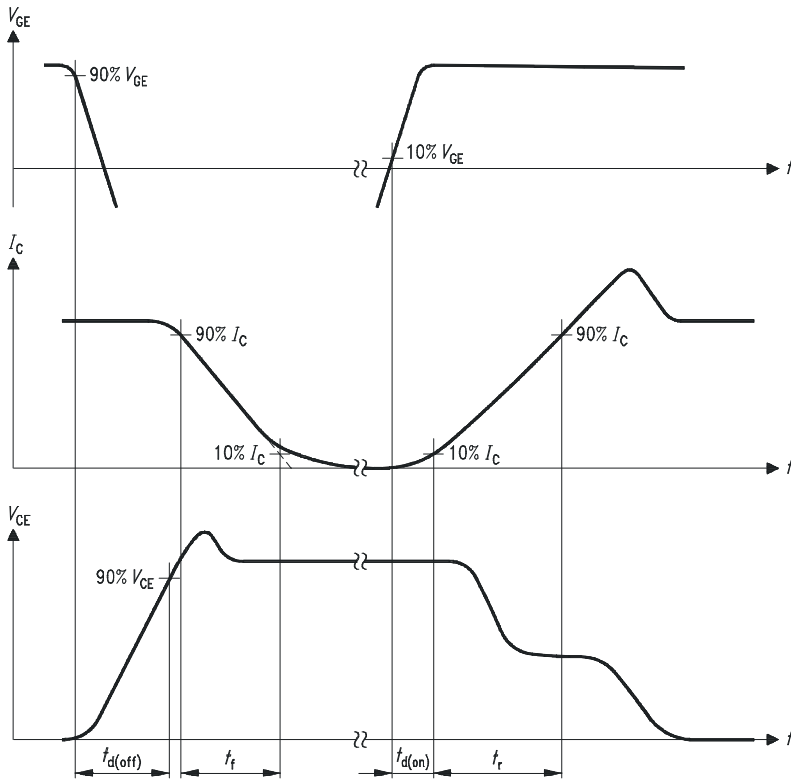

Figure A. Definition of switching times

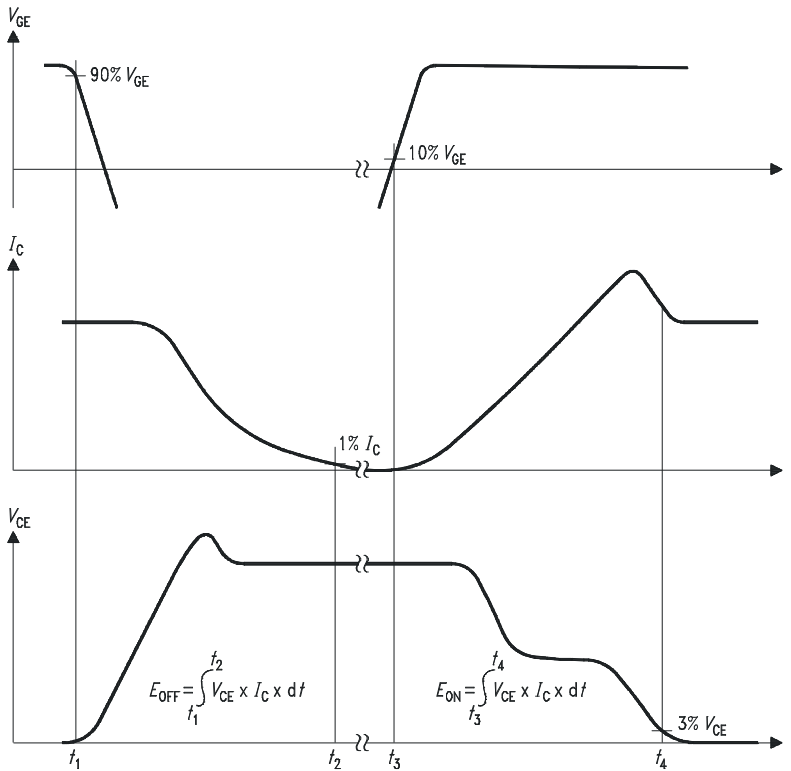

Figure B. Definition of switching losses

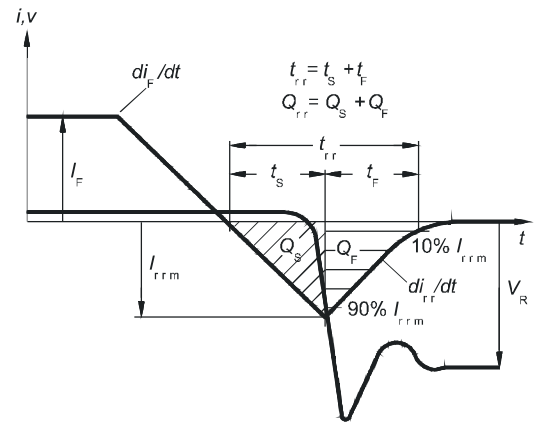

Figure C. Definition of diodes switching characteristics

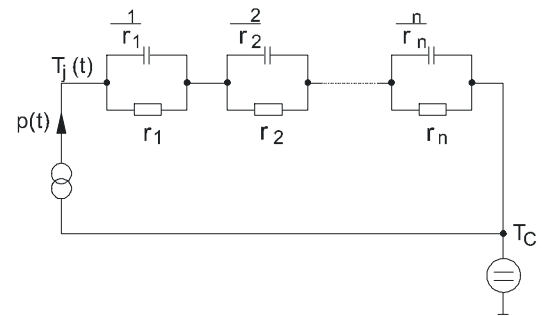

Figure D. Thermal equivalent circuit

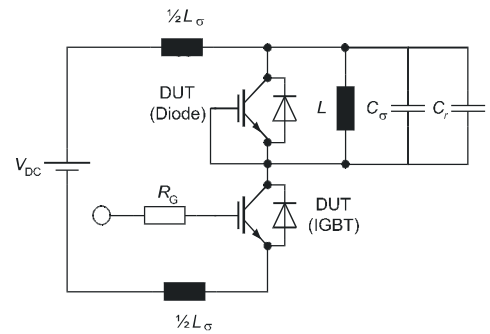

Figure E. Dynamic test circuit  
Parasitic inductance  $L_{\sigma}$ ,  
Parasitic capacitor  $C_{\sigma}$ ,  
Relief capacitor  $C_r$   
(only for ZVT switching)

**Revision History**

IDV30E60C

**Revision: 2010-07-26, Rev. 2.1**

Previous Revision

Revision	Date	Subjects (major changes since last revision)
2.1	-	Release of final datasheet

**We Listen to Your Comments**

Any information within this document that you feel is wrong, unclear or missing at all ?

Your feedback will help us to continuously improve the quality of this document.

Please send your proposal (including a reference to this document) to: [erratum@infineon.com](mailto:erratum@infineon.com)

**Published by****Infineon Technologies AG****81726 Munich, Germany****81726 München, Germany****© 2010 Infineon Technologies AG****All Rights Reserved.****Legal Disclaimer**

The information given in this document shall in no event be regarded as a guarantee of conditions or characteristics. With respect to any examples or hints given herein, any typical values stated herein and/or any information regarding the application of the device, Infineon Technologies hereby disclaims any and all warranties and liabilities of any kind, including without limitation, warranties of non-infringement of intellectual property rights of any third party.

**Information**

For further information on technology, delivery terms and conditions and prices, please contact the nearest Infineon Technologies Office ([www.infineon.com](http://www.infineon.com)).

**Warnings**

Due to technical requirements, components may contain dangerous substances. For information on the types in question, please contact the nearest Infineon Technologies Office. Infineon Technologies components may be used in life-support devices or systems only with the express written approval of Infineon Technologies, if a failure of such components can reasonably be expected to cause the failure of that life-support device or system or to affect the safety or effectiveness of that device or system. Life support devices or systems are intended to be implanted in the human body or to support and/or maintain and sustain and/or protect human life. If they fail, it is reasonable to assume that the health of the user or other persons may be endangered.