

Power management (dual digital transistors)

IMD16A

●Features

- 1) Two digital class transistors in a SMT package.
- 2) Up to 500mA can be driven.
- 3) Low $V_{CE(sat)}$ of drive transistors for low power dissipation.

●Package, marking, and packaging specifications

Part No.	IMD16A
Package	SMT6
Marking	D16
Code	T108
Basic ordering unit (pieces)	3000

●Absolute maximum ratings (Ta=25°C)

DTr1 (PNP)

Parameter	Symbol	Limits	Unit
Supply voltage	V_{CC}	-50	V
Input voltage	V_{IN}	-12	V
		5	
Output current	I_c	-500	mA

DTr2 (NPN)

Parameter	Symbol	Limits	Unit
Collector-base voltage	V_{CBO}	50	V
Collector-emitter voltage	V_{CEO}	50	V
Emitter-base voltage	V_{EBO}	5	V
Collector current	I_c	100	mA

Total

Parameter	Symbol	Limits	Unit
Collector power dissipation	P_d *	300(TOTAL)	mW
Junction temperature	T_j	150	°C
Storage temperature	T_{stg}	-55 to +150	°C

* 200mW per element must not be exceeded.

●Dimensions (Unit : mm)

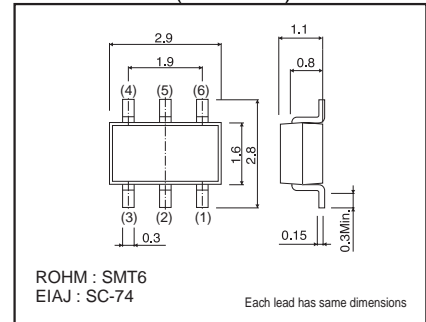

●Inner circuit

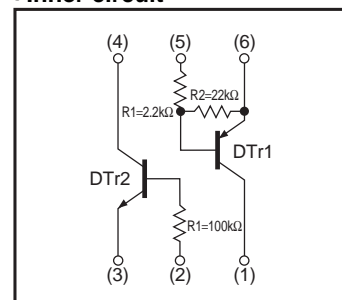

●Electrical characteristics (Ta=25°C)

DTr1

Parameter	Symbol	Min.	Typ.	Max.	Unit	Conditions
Input voltage	$V_{I(off)}$	–	–	–0.3	V	$V_{CC} = -5V, I_o = -100\mu A$
	$V_{I(on)}$	–2	–	–		$V_o = -0.3V, I_o = -20mA$
Output voltage	$V_{O(on)}$	–	–	–0.3	V	$I_o/I_i = -50mA / -2.5mA$
Input current	I_i	–	–	–3	mA	$V_i = -5V$
Output current	$I_{O(off)}$	–	–	–0.5	μA	$V_{CC} = -50V, V_i = 0V$
DC current gain	G_i *1	82	–	–	–	$I_o = -50mA, V_o = -5V$
Transition frequency	f_T *2	–	250	–	MHz	$V_{CE} = -10V, I_E = 50mA, f = 100MHz$
Input resistance	R_1	1.54	2.2	2.86	k Ω	–
Resistance ratio	R_2 / R_1	8	10	12	–	–

*1 Measured using pulse current. *2 Transition frequency of mounted transistor.

DTr2

Parameter	Symbol	Min.	Typ.	Max.	Unit	Conditions
Collector-base breakdown voltage	BV_{CBO}	50	–	–	V	$I_c = 50\mu A$
Collector-emitter breakdown voltage	BV_{CEO}	50	–	–	V	$I_c = 1mA$
Emitter-base breakdown voltage	BV_{EBO}	5	–	–	V	$I_E = 50\mu A$
Collector cutoff current	I_{CBO}	–	–	0.5	μA	$V_{CB} = 50V$
Emitter cutoff current	I_{EBO}	–	–	0.5	μA	$V_{EB} = 4V$
Collector-emitter saturation voltage	$V_{CE(sat)}$	–	–	0.3	V	$I_c/I_b = 1mA/0.1mA$
DC current transfer ratio	h_{FE}	100	250	600	–	$V_{CE} = 5V, I_c = 1mA$
Transition frequency	f_T *	–	250	–	MHz	$V_{CE} = 10V, I_E = -5mA, f = 100MHz$
Input resistance	R_1	70	100	130	k Ω	–

*Transition frequency of mounted transistor.

●Electrical characteristic curves

DT_{r1} (PNP)

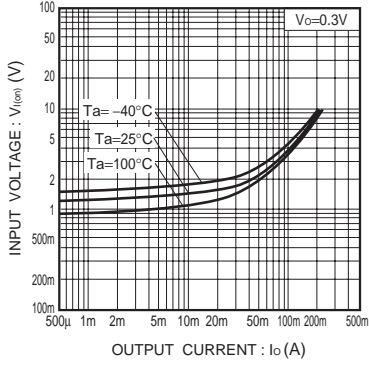

Fig.1 Input voltage vs. Output current (ON characteristics)

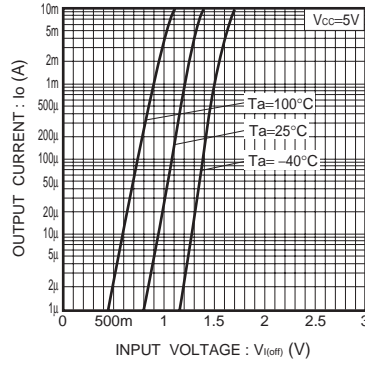

Fig.2 Output current vs. Input voltage (OFF characteristics)

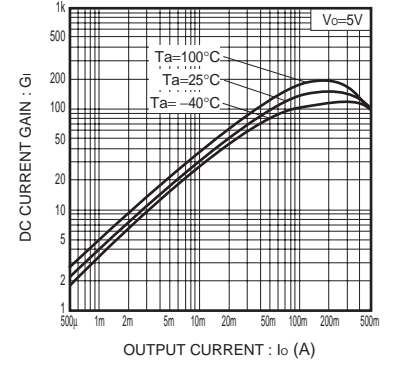

Fig.3 DC current gain vs. Output current characteristics

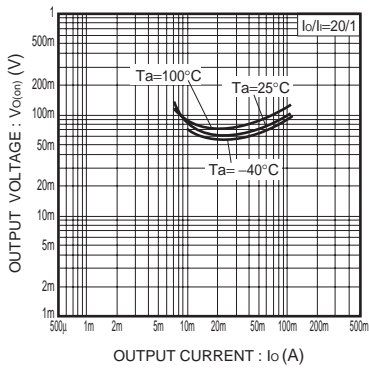

Fig.4 Output voltage vs. Output current characteristics

DT_{r2} (NPN)

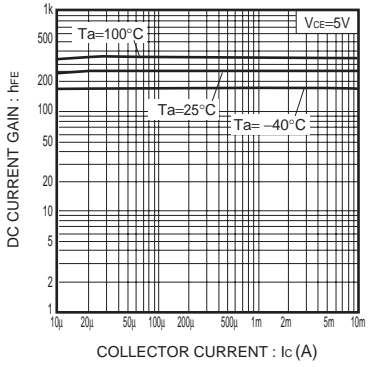

Fig.5 DC current gain vs. Output current characteristics

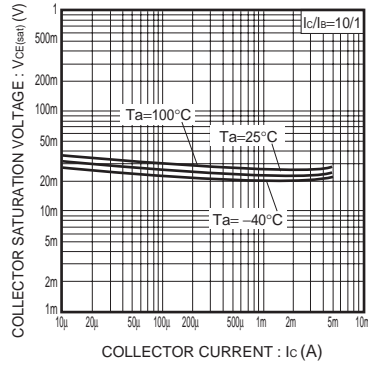

Fig.6 Output voltage vs. Output current characteristics

Notes

No copying or reproduction of this document, in part or in whole, is permitted without the consent of ROHM Co.,Ltd.

The content specified herein is subject to change for improvement without notice.

The content specified herein is for the purpose of introducing ROHM's products (hereinafter "Products"). If you wish to use any such Product, please be sure to refer to the specifications, which can be obtained from ROHM upon request.

Examples of application circuits, circuit constants and any other information contained herein illustrate the standard usage and operations of the Products. The peripheral conditions must be taken into account when designing circuits for mass production.

Great care was taken in ensuring the accuracy of the information specified in this document. However, should you incur any damage arising from any inaccuracy or misprint of such information, ROHM shall bear no responsibility for such damage.

The technical information specified herein is intended only to show the typical functions of and examples of application circuits for the Products. ROHM does not grant you, explicitly or implicitly, any license to use or exercise intellectual property or other rights held by ROHM and other parties. ROHM shall bear no responsibility whatsoever for any dispute arising from the use of such technical information.

The Products specified in this document are intended to be used with general-use electronic equipment or devices (such as audio visual equipment, office-automation equipment, communication devices, electronic appliances and amusement devices).

The Products specified in this document are not designed to be radiation tolerant.

While ROHM always makes efforts to enhance the quality and reliability of its Products, a Product may fail or malfunction for a variety of reasons.

Please be sure to implement in your equipment using the Products safety measures to guard against the possibility of physical injury, fire or any other damage caused in the event of the failure of any Product, such as derating, redundancy, fire control and fail-safe designs. ROHM shall bear no responsibility whatsoever for your use of any Product outside of the prescribed scope or not in accordance with the instruction manual.

The Products are not designed or manufactured to be used with any equipment, device or system which requires an extremely high level of reliability the failure or malfunction of which may result in a direct threat to human life or create a risk of human injury (such as a medical instrument, transportation equipment, aerospace machinery, nuclear-reactor controller, fuel-controller or other safety device). ROHM shall bear no responsibility in any way for use of any of the Products for the above special purposes. If a Product is intended to be used for any such special purpose, please contact a ROHM sales representative before purchasing.

If you intend to export or ship overseas any Product or technology specified herein that may be controlled under the Foreign Exchange and the Foreign Trade Law, you will be required to obtain a license or permit under the Law.



Thank you for your accessing to ROHM product informations.
More detail product informations and catalogs are available, please contact us.

ROHM Customer Support System

<http://www.rohm.com/contact/>