

SiBar Thyristor Surge Protectors

Raychem Circuit Protection's SiBar thyristor surge protection devices are designed to help protect sensitive telecommunication equipment from the hazards caused by lightning, power contact, and power induction. These devices have a high electrical surge capability to help protect against transient faults and a high off-state impedance, rendering them virtually transparent during normal system operation.

SiBar thyristor surge protectors are designed to assist telecommunication and computer telephony equipment in meeting the applicable requirements and industry specifications.

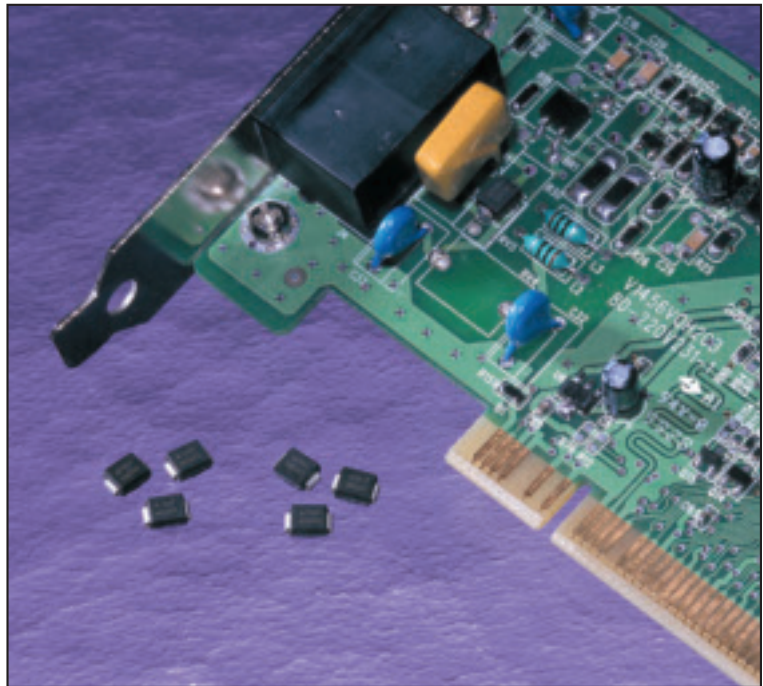

4

Benefits:

- Helps provide protection for sensitive telecom electronic equipment
- Low leakage current
- Low power dissipation
- Fast, reliable operation
- No wear-out mechanisms
- Helps designers meet worldwide telecom standards
- Helps reduce warranty and service costs
- Easy installation
- Helps improve power efficiency of equipment

Features:

- Bidirectional transient voltage protection
- High off-state impedance
- Low on-state voltage
- High surge capability
- Short-circuit failure mode
- Surface-mount technology
- Lead-free leads available on all parts

Applications:

- Modems
- Fax machines
- PBX systems
- Phones
- POS systems
- Analog and digital linecards
- Other customer premise and network equipment requiring protection

Devices in this section are grouped by:

Surge Capability, Maximum Off-State Voltage, Package Size

Step 1. Determine the circuit's operating parameters.

Fill in the following information about the circuit:

Maximum ambient operating temperature _____

Maximum DC supply voltage (V_{DC} Max.) _____

Maximum ringing (AC) voltage (V_{AC} Max.) _____

System voltage damage threshold _____

Maximum fault current and duration _____

Maximum system operating current _____

Applicable industry requirements _____

Step 2. Calculate the maximum operating voltage of your system.

Maximum operating voltage = V_{DC} Max. + (1.414 x V_{AC} Max.)

Refer to Table V1 to select a SiBar thyristor device with a maximum off-state voltage (V_{DM}) rating that is close to, but greater than, the maximum operating voltage of your system.

Step 3. Verify that the system voltage damage threshold is greater than the rated maximum breakover voltage (V_{BO}).

Refer to Table V1 to confirm that the maximum breakover voltage of the device you selected in Step 2 is less than the system voltage damage threshold.

Selection Guide for SiBar Thyristor Surge Protectors continued

Step 4. Verify that the maximum fault current of the system and its duration or the fault current defined in the industry specification(s) are less than the surge current rating of the device selected. For help in determining which industry specifications may apply, refer to the Protection Application Guide on the next page.

Refer to Table V2 for SiBar thyristor surge current ratings applicable to TIA 968-A (FCC Part 68), Telcordia GR-1089, ITU K.20, K.21, K.45 industry specifications.

Step 5. Verify that the maximum system operating current is less than the minimum hold current rating (I_H) in Table V1 for the device selected.

Using Figure V4, verify that I_H is greater than the maximum system operating current over the entire ambient operating temperature range. (As with I_H , V_{DM} and V_{BO} also vary with ambient temperature, to a lesser degree. Figures V2 and V3 can be used to determine that the device selected continues to meet your requirements over the ambient operating temperature range.)

Step 6. Verify that the dimensions in Table V4 for the SiBar thyristor device are compatible with the application's space requirements.

4

Protection Application Guide for SiBar Thyristor Surge Protectors

- To use this guide, follow the steps below:
1. Select your equipment type from the guide below.
 2. Select the type of protection depending on the agency and regional specifications in the second column.

Application	Region/ Specification	SiBar Thyristor Surge Protectors ¹	PolySwitch Resettable Devices		
			Key Device Selection Criteria Small Footprint	Low Resistance	Fast Time-to-Trip
Customer premises equipment, IT equipment Analog modems, V.90 modems, ISDN modems, xDSL modems, ADSL splitters, phone sets, fax machines, answering machines, caller ID, internet appliances, PBX systems, POS terminals, wall plugs	North America TIA-968-A (FCC Part 68), UL 1950, UL 1459	TVBxxxSA(-L) or TVAxxxSA(-L) with	TR600-150 TS600-170	TR600-150-RA TS600-200-RA	TR600-150-RB TS600-170
	Europe/Asia/ South America ITU K.21	TR/TS; TVBxxxSC(-L) with TS/TR or fuse TVBxxxSA(-L) TVAxxxSA(-L)	TR250-120 TR250-145 TS250-130 TSV250-130	TR250-180U TS250-130-RA TSV250-130	TR250-120T-R2 TS250-130-RB
Access network equipment (*) Remote terminals, line repeaters, multiplexers, cross-connects, WAN equipment	North America Telcordia GR-1089	TVBxxxSC(-L)	TR600-150-RA TS600-200-RA	TR600-160-RA TS600-200-RA	TR600-150-RB TS600-170
	Europe/Asia/ South America ITU K.45	TVBxxxSA(-L) TVAxxxSA(-L)	TR250-120 TR250-145 TS250-130 TSV250-130	TR250-180U TS250-130-RA TSV250-130	TR250-120T-R2 TS250-130-RB
Central office switching equipment (*) Analog/POTS linecards, ISDN linecards, xDSL modems, ADSL/VDSL splitters, T1/E1 linecards, multiplexers, CSU/DSU, servers	North America Telcordia GR-1089	TVBxxxSC(-L)	TR600-150-RA TS600-200-RA	TR600-160-RA TS600-200-RA	TR600-150-RB TS600-170
	Europe/Asia/ South America ITU K.20	TVBxxxSA(-L) TVAxxxSA(-L)	TR250-120 TR250-145 TS250-130 TSV250-130	TR250-180U TS250-130-RA TSV250-130	TR250-120T-R2 TS250-130-RB
Primary protection modules (*) MDF modules, Network Interface Devices (NID)	North America Telcordia GR-974	N/A	TR250-180U	TR250-180U	TR250-180U
	Europe/Asia/ South America ITU K.20	N/A	TGC250-120T TR250-120T TS250-130 TSV250-130	TC250-145T TR250-145-RA TS250-130-RA TSV250-130	TGC250-120T TR250-120T-R2 TS250-130-RB
Short-haul/intrabuilding communications equipment (*) LAN equipment, VoIP cards, cable telephony NIU's, wireless local loop handsets	North America Telcordia GR-1089 intrabuilding	TVBxxxSA(-L) TVAxxxSA(-L)	TSL250-080 TR250-120 TS250-130 TSV250-130	TR250-145 TR250-180U TS250-130-RA	TSV250-130 TR250-120T-R2 TSL250-080
	Europe/Asia/ South America ITU K.21	TVBxxxSA(-L) TVAxxxSA(-L)	TR250-120 TR250-145 TS250-130 TSV250-130	TR250-180U TS250-130-RA TSV250-130	TR250-120T-R2 TS250-130-RB
LAN intrabuilding power cross protection LAN equipment, VoIP cards, IP phones		TVBxxxSA(-L) TVAxxxSA(-L)	TSL250-080	TSL250-080	TSL250-080 TVAxxxSA
IEEE 802.3 Power over LAN protection Powered ethernet switches and terminals, IP phones, wireless LAN base stations, microcellular base stations, VoIP cards		N/A	miniSMD0C14 SMD030	SMD030-2018	SMD030-2018
Cable telephony powering systems Power passing taps		N/A	BBR550	BBR750	BBR550

Notes: This list is not exhaustive. Raychem Circuit Protection welcomes our customers' input for additional application ideas.

¹For more information on Raychem Circuit Protection PolySwitch resettable devices, refer to telecommunication and networking devices on page 301.

* For improved line balance in these applications, resistance-matched parts are recommended. See Telecom and Networking section, page 301 for details.

(-L) Lead-free leaded devices are also applicable for these applications.

Table V1. Product Electrical Characteristics for SiBar Thyristor Surge Protectors (-L: Lead-free leaded devices)

Part Number	V _{DM} Max. (V)	V _{BO} Max. (V)	I _H Min. (mA)	V _T Max. (V)	C ₁ Typ. (pF)
TVA270SA	270	365	150	3.0	22
TVA270SA-L	270	365	150	3.0	22
NEW TVB058SA-L	58	78	150	4.0	43
TVB170SA	170	265	150	4.0	20
TVB170SA-L	170	265	150	4.0	20
TVB200SA	200	320	150	4.0	20
TVB200SA-L	200	320	150	4.0	20
TVB270SA	270	365	150	4.0	20
TVB270SA-L	270	365	150	4.0	20
NEW TVB300SA-L	300	400	150	4.0	20
NEW TVB200SB-L	200	320	150	4.0	25
NEW TVB270SB-L	270	365	150	4.0	25
NEW TVB300SB-L	300	400	150	4.0	25
TVB170SC	170	265	150	4.0	50
TVB170SC-L	170	265	150	4.0	50
TVB200SC	200	320	150	4.0	50
TVB200SC-L	200	320	150	4.0	50
TVB270SC	270	365	150	4.0	50
TVB270SC-L	270	365	150	4.0	50
NEW TVB300SC-L	300	400	150	4.0	50

Notes: All electrical characteristics are measured at 25°C.

V_{DM} measured per UL497B pulse requirements: at max. off-state leakage current (I_{DM}) = 5 µA.

V_{BO} Measured at 100V/µs.

C₁ measured at 1 MHz with a 50 V_{DC} bias.

Table V2. Surge Current Rating for SiBar Thyristor Surge Protectors (-L: Lead-free leaded devices)

Part Description	TIA-968-A (FCC Part 68)*			Telcordia GR-1089*		IEC 61000-4-5*ITU K.20/21/45*		I _{TSM} Min. (A)	di/dt (A/µs)	dV/dt (V/µs)
	I _{pp} (A) 5 x 320 µs	I _{pp} (A) 10 x 560 µs	I _{pp} (A) 10 x 160 µs	I _{pp} (A) 10 x 1000 µs	I _{pp} (A) 2 x 10 µs	I _{pp} (A) 8 x 20 µs	I _{pp} (A) 5 x 310 µs			
TVA270SA	90	70	100	50	150	150	90	22	500	2000
TVA270SA-L	90	70	100	50	150	150	90	22	500	2000
NEW TVB058SA-L	55	55	70	50	150	150	55	22	500	2000
TVB170SA	90	70	100	50	150	150	90	22	500	2000
TVB170SA-L	90	70	100	50	150	150	90	22	500	2000
TVB200SA	90	70	100	50	150	150	90	22	500	2000
TVB200SA-L	90	70	100	50	150	150	90	22	500	2000
TVB270SA	90	70	100	50	150	150	90	22	500	2000
TVB270SA-L	90	70	100	50	150	150	90	22	500	2000
NEW TVB300SA-L	90	70	100	50	150	150	90	22	500	2000
NEW TVB200SB-L	100	100	150	80	250	250	100	30	500	2000
NEW TVB270SB-L	100	100	150	80	250	250	100	30	500	2000
NEW TVB300SB-L	100	100	150	80	250	250	100	30	500	2000
TVB170SC	100	150	200	100	500	400	150	60	500	2000
TVB170SC-L	100	150	200	100	500	400	150	60	500	2000
TVB200SC	100	150	200	100	500	400	150	60	500	2000
TVB200SC-L	100	150	200	100	500	400	150	60	500	2000
TVB270SC	100	150	200	100	500	400	150	60	500	2000
TVB270SC-L	100	150	200	100	500	400	150	60	500	2000
NEW TVB300SC-L	100	150	200	100	500	400	150	60	500	2000

Notes: *Lightning current wave forms for applicable industry specification.

I_{TSM} peak on-state surge current is measured at 60 Hz, one cycle.

di/dt: critical rate-of-rise of on-state current (pulsed power amplifier V_{max}=600V; C=30 µF).

dV/dt: critical rate-of-rise of off-stage voltage (linear wave form, V_p = rated V_{BO}, T_j = 25°C).

Figure V1. Voltage-Current Characteristics

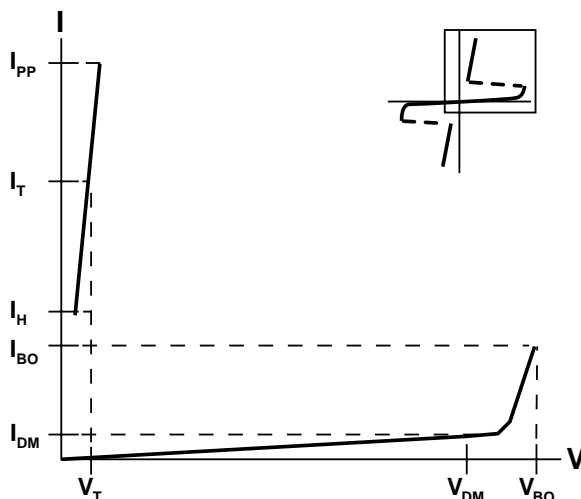

Note: The voltage current (V-I) is useful in depicting the electrical characteristics of the SiBar thyristor surge protectors in relation to each other.

4

Table V3. Parameter Definitions for SiBar Thyristor Surge Protectors

Symbol	Parameter	Definition
V_{BO}	Breakover voltage	Maximum voltage across the device at breakdown measured under a specified voltage and current rate of rise.
I_{BO}	Breakover current	Instantaneous current flowing at the breakover voltage (V_{BO}).
I_H	Hold current	Minimum current required to maintain the device in the on-state.
I_T	On-state current	Current through the device in the on-state condition.
V_T	On-state voltage	Voltage across the device in the on-state condition at a specified current (I_T).
V_{DM}	Maximum off-state voltage	Maximum DC voltage that can be applied to the device while maintaining it in the off-state condition.
I_{DM}	Off-state current	Maximum DC value of current that results from the application of the maximum off-state voltage.
I_{PP}	Peak pulse current	Rated peak pulse current of specified amplitude and waveshape that may be applied without damage.
di/dt, dv/dt	Critical rate of rise of on-state current and voltage	Maximum current and voltage rate of rise the device can withstand without damage.

Figures V2–V5. Typical Electrical Characteristics vs. Temperature

Figure V2. Off-state Voltage vs. Temperature

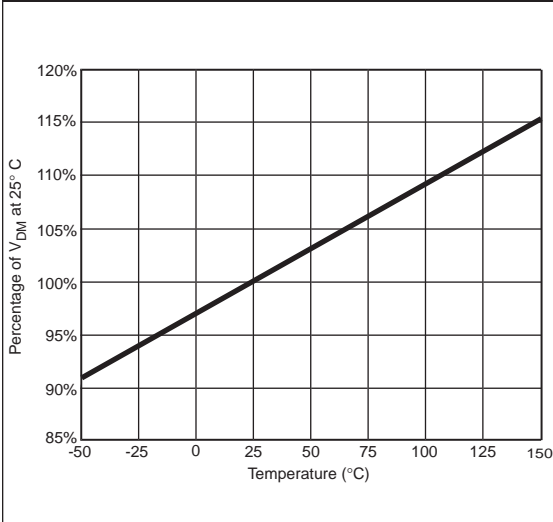

Figure V3. Breakover Voltage vs. Temperature

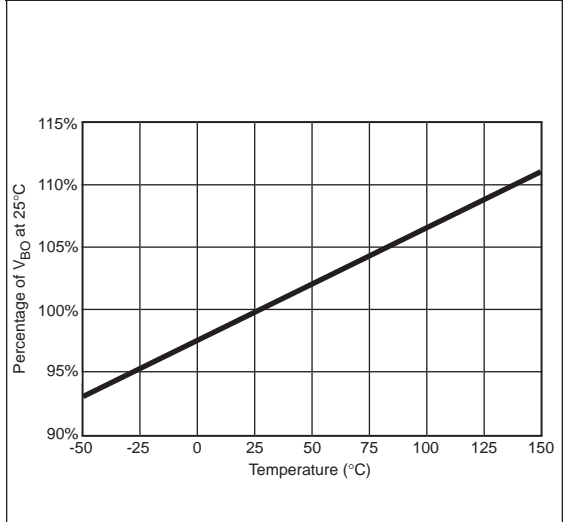

Figure V4. Hold Current vs. Temperature

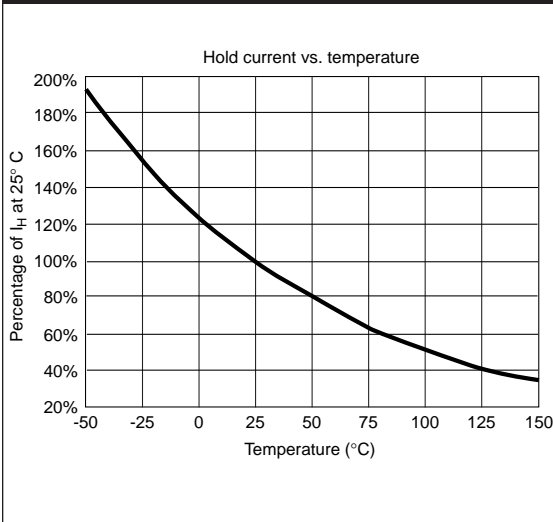
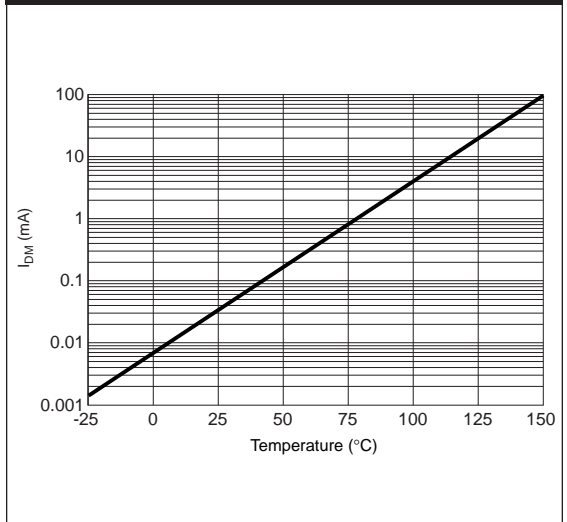

Figure V5. Off-state Current vs. Temperature



Physical Description for Dimensions for SiBar Thyristor Surge Protectors

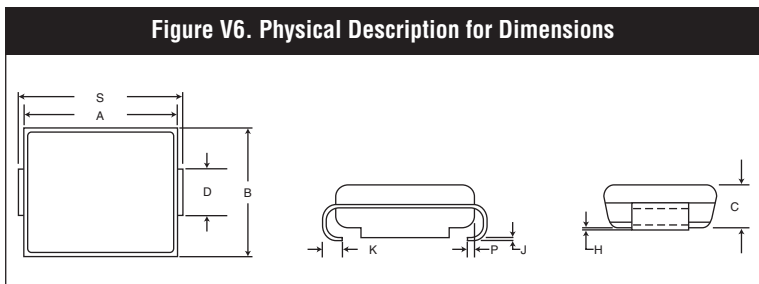

Table V4. Product Dimensions for SiBar Thyristor Surge Protectors in Millimeters (Inches)

Dimension	A		B		C		D*		H		J		K		P	S	
	Min.	Max.	Min.	Max.	Min.	Max.	Min.	Max.	Min.	Max.	Min.	Max.	Min.	Max.	Ref.	Min.	Max.
TVBxxxSA(-L), TVBxxxSB-L, TVBxxxSC(-L)	4.06 (0.160)	4.57 (0.180)	3.30 (0.130)	3.81 (0.150)	1.90 (0.075)	2.41 (0.095)	1.96 (0.077)	2.11 (0.083)	0.051 (0.002)	0.152 (0.006)	0.15 (0.006)	0.30 (0.012)	0.76 (0.030)	1.27 (0.050)	0.51 (0.020)	5.21 (0.205)	5.59 (0.220)
TVA270SA(-L)	4.06 (0.160)	4.57 (0.180)	2.29 (0.090)	2.92 (0.115)	1.91 (0.075)	2.41 (0.095)	1.27 (0.050)	1.63 (0.064)	0.010 (0.004)	0.152 (0.006)	0.15 (0.006)	0.41 (0.016)	0.76 (0.030)	1.52 (0.060)	—	4.83 (0.190)	5.59 (0.220)

Notes: *D dimension is measured within dimension P.

TVA series devices use industry standard SMA package type.

TVB series devices use industry standard SMB package type.

4

All devices are bidirectional and may be oriented in either direction for installation.

Table V5. Physical Characteristics and Environmental Specifications for SiBar Thyristor Surge Protectors

Lead material	Tin/lead finish or matte tin finish(-L devices)
Encapsulating material	Epoxy, meets UL94V-0 requirements
Solderability	per MIL-STD-750, Method 2026
Solder heat withstand	per MIL-STD-750, Method 2031
Solvent resistance	per MIL-STD-750, Method 1022
Mechanical shock	per MIL-STD-750, Method 2016
Vibration	per MIL-STD-750, Method 2056
Storage temperature (°C)	-55 to 150
Operating temperature (°C)	-40 to 125
Junction temperature (°C)	150
Maximum lead temperature for soldering pupose; 10 seconds (°C)	+260

Table V6. Reliability Tests for SiBar Thyristor Surge Protectors

Test	Conditions	Duration
High temperature, reverse bias	+100°C, 50 V _{DC} bias	1000 hours
High humidity, high temperature, reverse bias	85% RH, +85°C, 50 V _{DC} bias	1000 hours
High temperature storage life	+150°C	1000 hours
Temperature cycling	-65°C to +150°C, 15 minute dwell	1000 cycles
Autoclave	100% RH, +121°C, 15 PSI	96 hours

Table V7. Packaging and Marking Information for SiBar Thyristor Surge Protectors (-L: Lead-free leaded devices)

Part Description	Tape and Reel Quantity	Standard Package	Part Marking	Recommended Pad Layout (mil/inch)			Agency Recognition
				Dimension A (Nom.)	Dimension B (Nom.)	Dimension C (Nom.)	
TVA270SA	5,000	20,000	270A	2.0 (0.079)	2.0 (0.079)	2.0 (0.079)	UL
TVA270SA-L	5,000	20,000	REAB	2.0 (0.079)	2.0 (0.079)	2.0 (0.079)	UL
NEW TVB058SA-L	2,500	10,000	058A	2.261 (0.089)	2.159 (0.085)	2.743 (0.108)	UL
TVB170SA	2,500	10,000	RCBB	2.261 (0.089)	2.159 (0.085)	2.743 (0.108)	UL
TVB170SA-L	2,500	10,000	170A	2.261 (0.089)	2.159 (0.085)	2.743 (0.108)	UL
TVB200SA	2,500	10,000	RDBB	2.261 (0.089)	2.159 (0.085)	2.743 (0.108)	UL
TVB200SA-L	2,500	10,000	200A	2.261 (0.089)	2.159 (0.085)	2.743 (0.108)	UL
TVB270SA	2,500	10,000	REBB	2.261 (0.089)	2.159 (0.085)	2.743 (0.108)	UL
TVB270SA-L	2,500	10,000	270A	2.261 (0.089)	2.159 (0.085)	2.743 (0.108)	UL
NEW TVB300SA-L	2,500	10,000	300A	2.261 (0.089)	2.159 (0.085)	2.743 (0.108)	UL
NEW TVB200SB-L	2,500	10,000	200B	2.261 (0.089)	2.159 (0.085)	2.743 (0.108)	UL
NEW TVB270SB-L	2,500	10,000	270B	2.261 (0.089)	2.159 (0.085)	2.743 (0.108)	UL
NEW TVB300SB-L	2,500	10,000	300B	2.261 (0.089)	2.159 (0.085)	2.743 (0.108)	UL
TVB170SC	2,500	10,000	RCBD	2.261 (0.089)	2.159 (0.085)	2.743 (0.108)	UL
TVB170SC-L	2,500	10,000	170C	2.261 (0.089)	2.159 (0.085)	2.743 (0.108)	UL
TVB200SC	2,500	10,000	RDBD	2.261 (0.089)	2.159 (0.085)	2.743 (0.108)	UL
TVB200SC-L	2,500	10,000	200C	2.261 (0.089)	2.159 (0.085)	2.743 (0.108)	UL
TVB270SC	2,500	10,000	REBD	2.261 (0.089)	2.159 (0.085)	2.743 (0.108)	UL
TVB270SC-L	2,500	10,000	270C	2.261 (0.089)	2.159 (0.085)	2.743 (0.108)	UL
NEW TVB300SC-L	2,500	10,000	300C	2.261 (0.089)	2.159 (0.085)	2.743 (0.108)	UL

Recommended Pad Layout for SiBar Thyristor Surge Protectors

Figure V7. Recommended Pad Layout

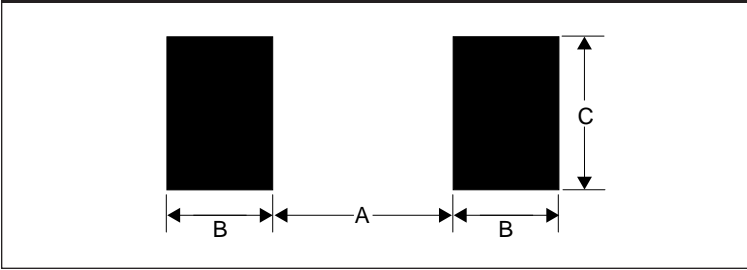

Agency Recognition for SiBar Thyristor Surge Protectors

UL File # E179610

Part Numbering System for SiBar Thyristor Surge Protectors

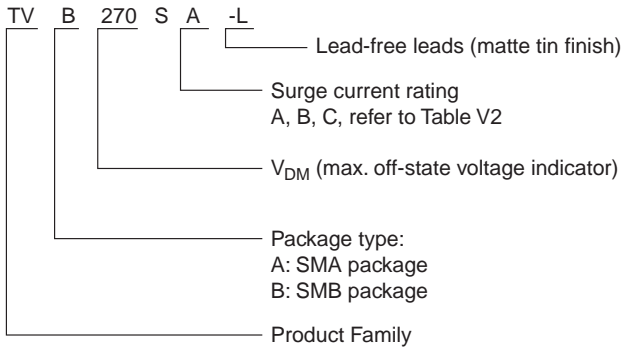

4

Solder Reflow and Rework Recommendations for SiBar Thyristor Surge Protectors

SiBar thyristor devices are compatible with standard reflow and wave soldering techniques.

Solder Reflow

- Recommended reflow methods: IR, vapor phase oven, hot air oven.
- Always preheat the device to prevent excessive thermal shock and stress.
- Recommended maximum paste thickness of 0.25mm (0.010 in.).
- Devices may be cleaned using standard industry methods and solvents.

Solder Rework

- Use standard industry practices for the SiBar Thyristor Surge Protectors.

Figure V8

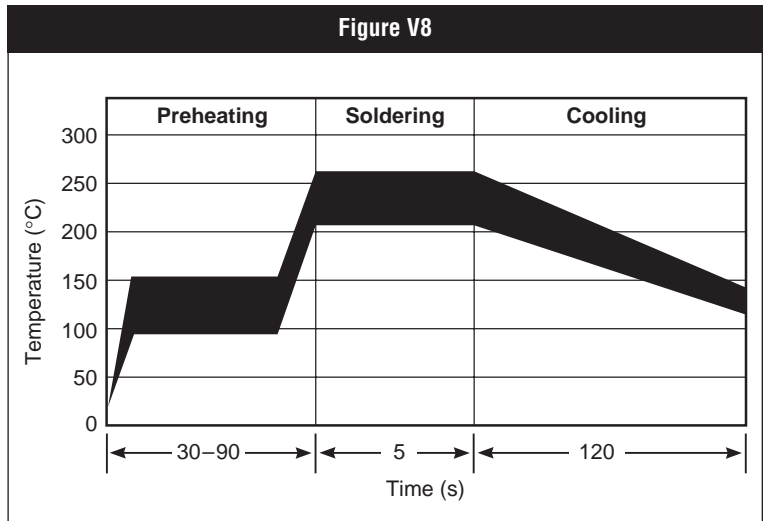
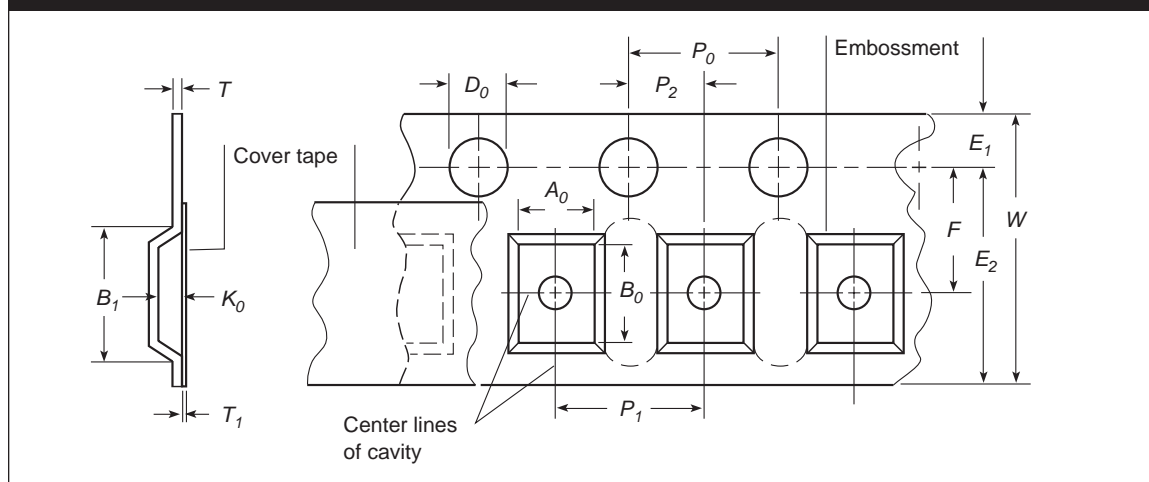

Table V8. Tape and Reel Specifications for SiBar Thyristor Surge Protectors

SiBar thyristor devices are supplied on tape and reel per EIA481-1 standard. (See Figures V9 and V10 for details.)

Description	TVB Series		TVA Series	
	Dimensions (mm)	Tolerance (mm)	Dimensions (mm)	Tolerance (mm)
W	12	+/- 0.30	12	+/- 0.3
P ₀	4.0	+/- 0.10	4.0	+/- 0.10
P ₁	8.0	+/- 0.10	8.0	+/- 0.10
P ₂	2.0	+/- 0.10	2.0	+/- 0.10
A ₀	4.3	—	2.9	+/- 0.10
B ₀	6.2	—	5.59	+/- 0.10
B ₁ max.	8.2	—	8.2	—
D ₀	1.5	+ 0.1, -0.0	1.5	+ 0.1, -0
F	5.5	+/- 0.05	5.5	+/- 0.05
E ₁	1.75	+/- 0.10	1.75	+/- 0.10
E ₂ min.	9.85	—	9.85	—
T max.	0.6	—	0.6	—
T ₁ max.	0.1	—	0.1	—
K ₀ max.	2.59	+/- 0.10	2.36	+/- 0.10
Leader min.	390	—	390	—
Trailer min.	160	—	160	—

Figure V9. EIA Referenced Taped Component Dimensions for SiBar Thyristor Surge Protectors

Reel Dimension	
A max.	330
N min.	50
W1	12.4 + 2.0, -0
W2 max.	18.4

Figure V10. EIA Referenced Reel Dimensions for SiBar Thyristor Protectors

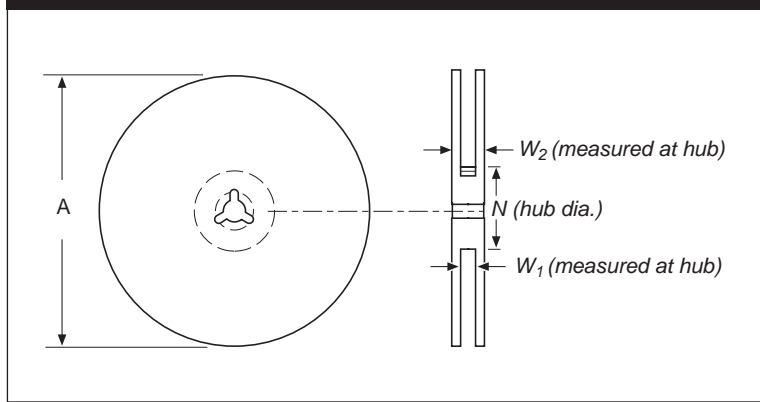

WARNING:

- Operation beyond the maximum ratings or improper use may result in device damage and possible electrical arcing and flame.
- The devices are intended for protection against occasional overvoltage fault conditions and should not be used when repeated fault conditions or prolonged trip events are anticipated.
- Device performance can be impacted negatively if devices are handled in a manner inconsistent with recommended electronic, thermal, and mechanical procedures for electronic components.

4