

Six-IGBT IGBTMOD™ H-Series Module 75 Amperes/600 Volts

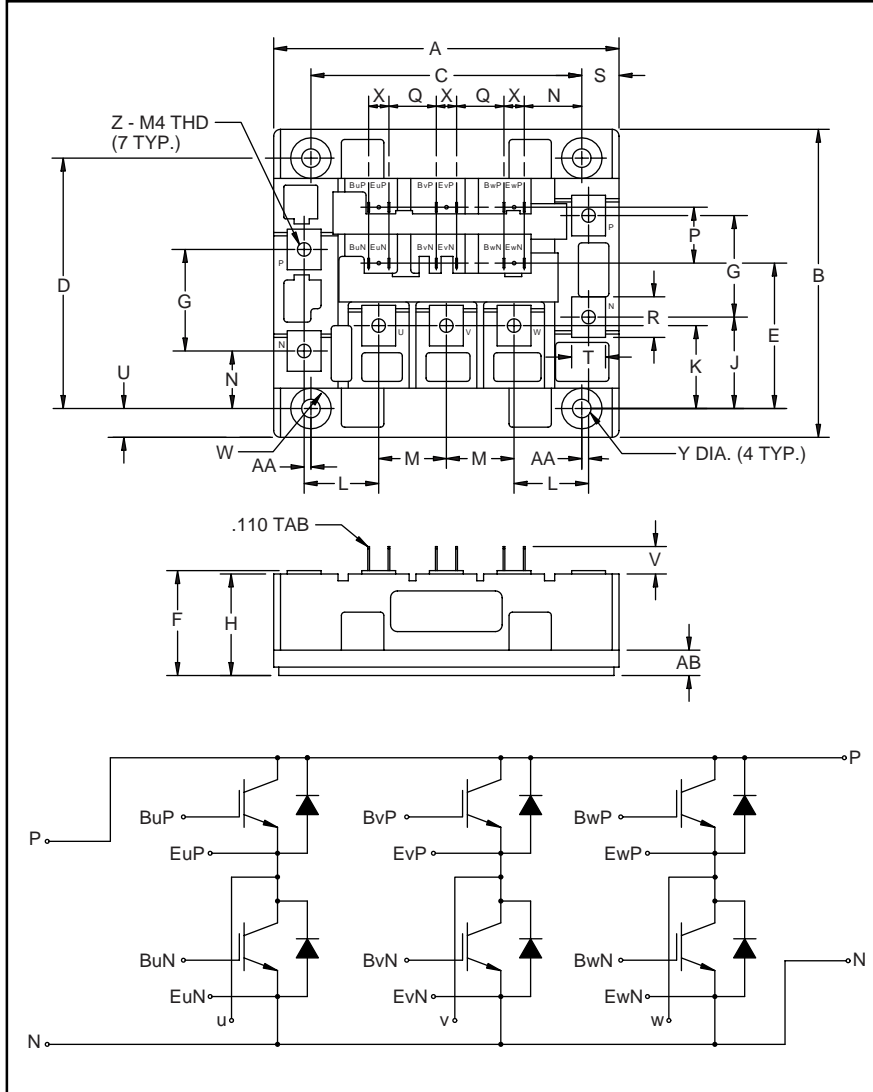

Outline Drawing and Circuit Diagram

Dimensions	Inches	Millimeters
A	4.02±0.02	102±0.5
B	3.58±0.02	91.0±0.5
C	3.15±0.01	80.0±0.25
D	2.913±0.01	74.0±0.25
E	1.69	43.0
F	1.18+0.06/-0.02	30.0+1.5/-0.5
G	1.18	30.0
H	1.16	29.5
J	1.06	27.0
K	0.96	24.5
L	0.87	22.0
M	0.79	20.0
N	0.67	17.0

Dimensions	Inches	Millimeters
P	0.65	16.5
Q	0.55	14.0
R	0.47	12.0
S	0.43	11.0
T	0.39	10.0
U	0.33	8.5
V	0.32	8.1
W	0.24 Rad.	Rad. 6.0
X	0.24	6.0
Y	0.22 Dia.	Dia. 5.5
Z	M4 Metric	M4
AA	0.08	2.0
AB	0.28	7.0



Description:

Powerex IGBTMOD™ Modules are designed for use in switching applications. Each module consists of six IGBT Transistors in a three phase bridge configuration, with each transistor having a reverse-connected super-fast recovery free-wheel diode. All components and interconnects are isolated from the heat sinking baseplate, offering simplified system assembly and thermal management.

Features:

- Low Drive Power
- Low $V_{CE(sat)}$
- Discrete Super-Fast Recovery (70ns) Free-Wheel Diode
- High Frequency Operation (20-25kHz)
- Isolated Baseplate for Easy

Applications:

- AC Motor Control
- Motion/Servo Control
- UPS
- Welding Power Supplies
- Laser Power Supplies

Ordering Information:

Example: Select the complete part module number you desire from the table below -i.e. CM75TF-12H is a 600V (V_{CES}), 75 Ampere Six-IGBT IGBTMOD™ Power Module.

Type	Current Rating Amperes	V_{CES} Volts (x 50)
CM	75	12

CM75TF-12H

Six-IGBT IGBTMOD™ H-Series Module

75 Amperes/600 Volts

Absolute Maximum Ratings, $T_j = 25\text{ }^\circ\text{C}$ unless otherwise specified

Ratings	Symbol	CM75TF-12H	Units
Junction Temperature	T_j	-40 to 150	$^\circ\text{C}$
Storage Temperature	T_{stg}	-40 to 125	$^\circ\text{C}$
Collector-Emitter Voltage (G-E SHORT)	V_{CES}	600	Volts
Gate-Emitter Voltage	V_{GES}	± 20	Volts
Collector Current	I_C	75	Amperes
Peak Collector Current	I_{CM}	150*	Amperes
Diode Forward Current	I_F	75	Amperes
Diode Forward Surge Current	I_{FM}	150*	Amperes
Power Dissipation	P_d	310	Watts
Max. Mounting Torque M4 Terminal Screws	-	13	in-lb
Max. Mounting Torque M5 Mounting Screws	-	17	in-lb
Module Weight (Typical)	-	540	Grams
V Isolation	V_{RMS}	2500	Volts

* Pulse width and repetition rate should be such that device junction temperature does not exceed the device rating.

Static Electrical Characteristics, $T_j = 25\text{ }^\circ\text{C}$ unless otherwise specified

Characteristics	Symbol	Test Conditions	Min.	Typ.	Max.	Units
Collector-Cutoff Current	I_{CES}	$V_{CE} = V_{CES}, V_{GE} = 0V$	-	-	1.0	mA
Gate Leakage Current	I_{GES}	$V_{GE} = V_{GES}, V_{CE} = 0V$	-	-	0.5	μA
Gate-Emitter Threshold Voltage	$V_{GE(th)}$	$I_C = 7.5\text{mA}, V_{CE} = 10V$	4.5	6.0	7.5	Volts
Collector-Emitter Saturation Voltage	$V_{CE(sat)}$	$I_C = 75A, V_{GE} = 15V$	-	2.1	2.8**	Volts
		$I_C = 75A, V_{GE} = 15V, T_j = 150^\circ\text{C}$	-	2.15	-	Volts
Total Gate Charge	Q_G	$V_{CC} = 300V, I_C = 75A, V_{GS} = 15V$	-	225	-	nC
Diode Forward Voltage	V_{FM}	$I_E = 75A, V_{GS} = 0V$	-	-	2.8	Volts

** Pulse width and repetition rate should be such that device junction temperature rise is negligible.

Dynamic Electrical Characteristics, $T_j = 25\text{ }^\circ\text{C}$ unless otherwise specified

Characteristics	Symbol	Test Conditions	Min.	Typ.	Max.	Units
Input Capacitance	C_{ies}		-	-	7.5	nF
Output Capacitance	C_{oes}	$V_{GE} = 0V, V_{CE} = 10V, f = \text{MHz}$	-	-	2.6	nF
Reverse Transfer Capacitance	C_{res}		-	-	1.5	nF
Resistive	Turn-on Delay Time	$V_{CC} = 300V, I_C = 75A,$	-	-	120	ns
Load	Rise Time					
Switching	Turn-off Delay Time	$V_{GE1} = V_{GE2} = 15V, R_G = 8.3\Omega$	-	-	200	ns
	Times					
Diode Reverse Recovery Time	t_{rr}	$I_E = 75A, di_E/dt = -150A/\mu\text{s}$	-	-	110	ns
Diode Reverse Recovery Charge	Q_{rr}	$I_E = 75A, di_E/dt = -150A/\mu\text{s}$	-	0.20	-	μC

Thermal and Mechanical Characteristics, $T_j = 25\text{ }^\circ\text{C}$ unless otherwise specified

Characteristics	Symbol	Test Conditions	Min.	Typ.	Max.	Units
Thermal Resistance, Junction to Case	$R_{th(j-c)}$	Per IGBT	-	-	0.40	$^\circ\text{C/W}$
Thermal Resistance, Junction to Case	$R_{th(j-c)}$	Per FWDi	-	-	0.90	$^\circ\text{C/W}$
Contact Thermal Resistance	$R_{th(c-f)}$	Per Module, Thermal Grease Applied	-	-	0.033	$^\circ\text{C/W}$

CM75TF-12H
Six-IGBT IGBTMOD™ H-Series Module
 75 Amperes/600 Volts

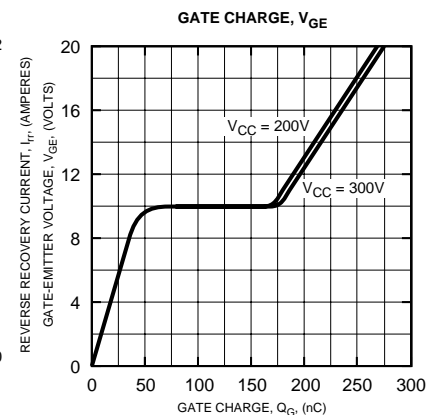
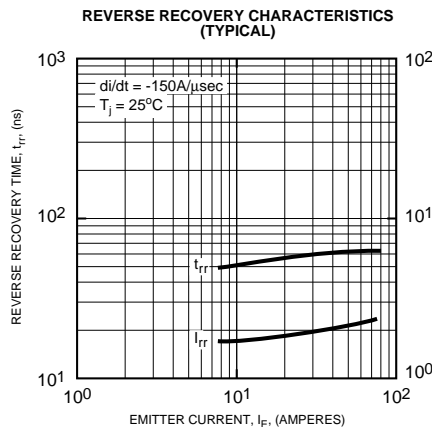
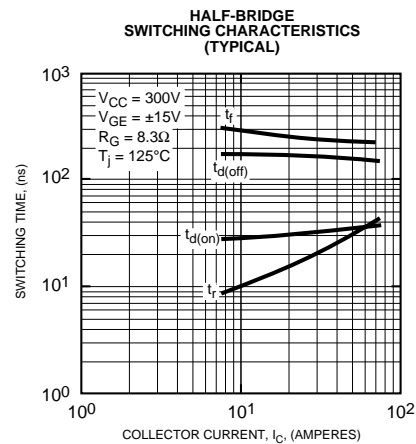
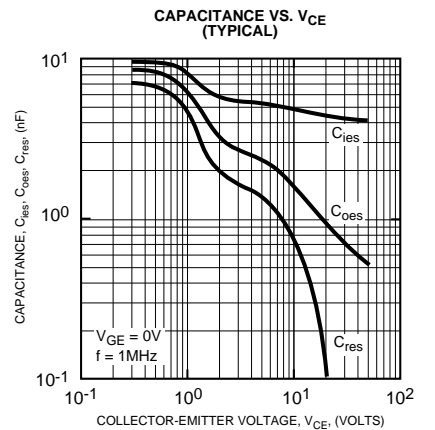
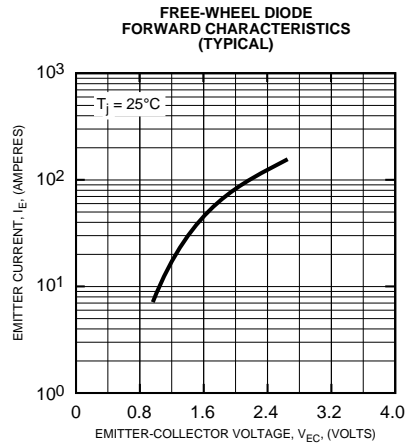
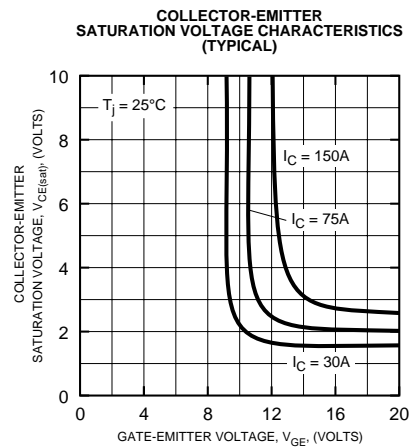
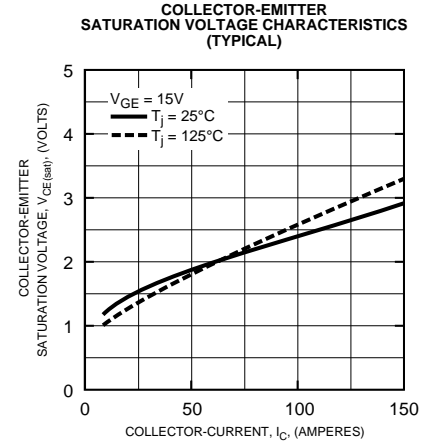
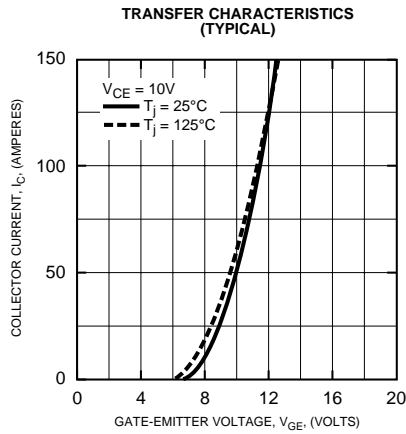
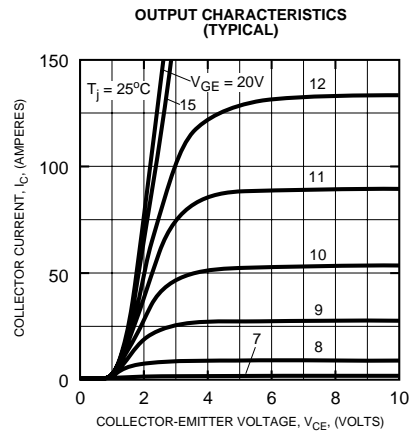

CM75TF-12H
Six-IGBT IGBTMOD™ H-Series Module
 75 Amperes/600 Volts

