



# RF Power Field Effect Transistors

## N-Channel Enhancement-Mode Lateral MOSFETs

Designed for broadband commercial and industrial applications with frequencies up to 1000 MHz. The high gain and broadband performance of these devices make them ideal for large-signal, common-source amplifier applications in 28 volt base station equipment.

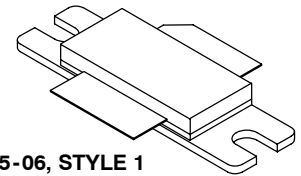
- Typical Single-Carrier N-CDMA Performance:  $V_{DD} = 28$  Volts,  $I_{DQ} = 1400$  mA,  $P_{out} = 40$  Watts Avg.,  $f = 880$  MHz, IS-95 CDMA (Pilot, Sync, Paging, Traffic Codes 8 Through 13). Channel Bandwidth = 1.2288 MHz, PAR = 9.8 dB @ 0.01% Probability on CCDF.  
 Power Gain — 20.8 dB  
 Drain Efficiency — 31.3%  
 Device Output Signal PAR — 8.1 dB @ 0.01% Probability on CCDF  
 ACPR @ 750 kHz Offset — -46.5 dBc in 30 kHz Channel Bandwidth
- Capable of Handling 10:1 VSWR, @ 32 Vdc, 880 MHz,  $P_{out} = 270$  W CW (2 dB Input Overdrive from Rated  $P_{out}$ ), Designed for Enhanced Ruggedness

### Features

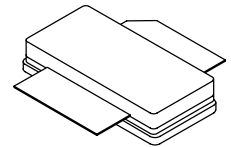
- 100% PAR Tested for Guaranteed Output Power Capability
- Characterized with Series Equivalent Large-Signal Impedance Parameters
- Internally Matched for Ease of Use
- Greater Negative Gate-Source Voltage Range for Improved Class C Operation
- Qualified Up to a Maximum of 32  $V_{DD}$  Operation
- Integrated ESD Protection
- RoHS Compliant
- In Tape and Reel. R3 Suffix = 250 Units per 56 mm, 13 inch Reel.

**MRFE6S9201HR3**  
**MRFE6S9201HSR3**

**880 MHz, 40 W AVG., 28 V**  
**SINGLE N-CDMA**  
**LATERAL N-CHANNEL**  
**RF POWER MOSFETs**



**CASE 465-06, STYLE 1**  
**NI-780**  
**MRFE6S9201HR3**



**CASE 465A-06, STYLE 1**  
**NI-780S**  
**MRFE6S9201HSR3**

**Table 1. Maximum Ratings**

Rating	Symbol	Value	Unit
Drain-Source Voltage	$V_{DSS}$	-0.5, +66	Vdc
Gate-Source Voltage	$V_{GS}$	-6.0, +10	Vdc
Storage Temperature Range	$T_{stg}$	-65 to +150	°C
Case Operating Temperature	$T_C$	150	°C
Operating Junction Temperature (1,2)	$T_J$	225	°C

**Table 2. Thermal Characteristics**

Characteristic	Symbol	Value (2,3)	Unit
Thermal Resistance, Junction to Case	$R_{\theta JC}$		°C/W
Case Temperature 85°C, 197 W CW		0.34	
Case Temperature 75°C, 40 W CW		0.33	

1. Continuous use at maximum temperature will affect MTTF.
2. MTTF calculator available at <http://www.freescale.com/rf>. Select Software & Tools/Development Tools/Calculators to access MTTF calculators by product.
3. Refer to AN1955, *Thermal Measurement Methodology of RF Power Amplifiers*. Go to <http://www.freescale.com/rf>. Select Documentation/Application Notes - AN1955.

**Table 3. ESD Protection Characteristics**

Test Methodology	Class
Human Body Model (per JESD22-A114)	1B (Minimum)
Machine Model (per EIA/JESD22-A115)	A (Minimum)
Charge Device Model (per JESD22-C101)	IV (Minimum)

**Table 4. Electrical Characteristics** ( $T_C = 25^\circ\text{C}$  unless otherwise noted)

Characteristic	Symbol	Min	Typ	Max	Unit
<b>Off Characteristics</b>					
Zero Gate Voltage Drain Leakage Current ( $V_{DS} = 66\text{ Vdc}$ , $V_{GS} = 0\text{ Vdc}$ )	$I_{DSS}$	—	—	10	$\mu\text{Adc}$
Zero Gate Voltage Drain Leakage Current ( $V_{DS} = 28\text{ Vdc}$ , $V_{GS} = 0\text{ Vdc}$ )	$I_{DSS}$	—	—	1	$\mu\text{Adc}$
Gate-Source Leakage Current ( $V_{GS} = 5\text{ Vdc}$ , $V_{DS} = 0\text{ Vdc}$ )	$I_{GSS}$	—	—	10	$\mu\text{Adc}$

**On Characteristics**

Gate Threshold Voltage ( $V_{DS} = 10\text{ Vdc}$ , $I_D = 400\ \mu\text{Adc}$ )	$V_{GS(th)}$	1.5	2.2	3	Vdc
Gate Quiescent Voltage ( $V_{DD} = 28\text{ Vdc}$ , $I_D = 1400\text{ mAdc}$ , Measured in Functional Test)	$V_{GS(Q)}$	2.25	2.9	3.75	Vdc
Drain-Source On-Voltage ( $V_{GS} = 10\text{ Vdc}$ , $I_D = 4.11\text{ Adc}$ )	$V_{DS(on)}$	0.1	0.21	0.35	Vdc

**Dynamic Characteristics** <sup>(1)</sup>

Reverse Transfer Capacitance ( $V_{DS} = 28\text{ Vdc} \pm 30\text{ mV(rms)ac}$ @ 1 MHz, $V_{GS} = 0\text{ Vdc}$ )	$C_{rss}$	—	2.3	—	pF
Output Capacitance ( $V_{DS} = 28\text{ Vdc} \pm 30\text{ mV(rms)ac}$ @ 1 MHz, $V_{GS} = 0\text{ Vdc}$ )	$C_{oss}$	—	90	—	pF
Input Capacitance ( $V_{DS} = 28\text{ Vdc}$ , $V_{GS} = 0\text{ Vdc} \pm 30\text{ mV(rms)ac}$ @ 1 MHz)	$C_{iss}$	—	480	—	pF

**Functional Tests** (In Freescale Test Fixture, 50 ohm system)  $V_{DD} = 28\text{ Vdc}$ ,  $I_{DQ} = 1400\text{ mA}$ ,  $P_{out} = 40\text{ W Avg. N-CDMA}$ ,  $f = 880\text{ MHz}$ , Single-Carrier N-CDMA, 1.2288 MHz Channel Bandwidth Carrier. ACPR measured in 30 kHz Channel Bandwidth @  $\pm 750\text{ kHz}$  Offset. PAR = 9.8 dB @ 0.01% Probability on CCDF.

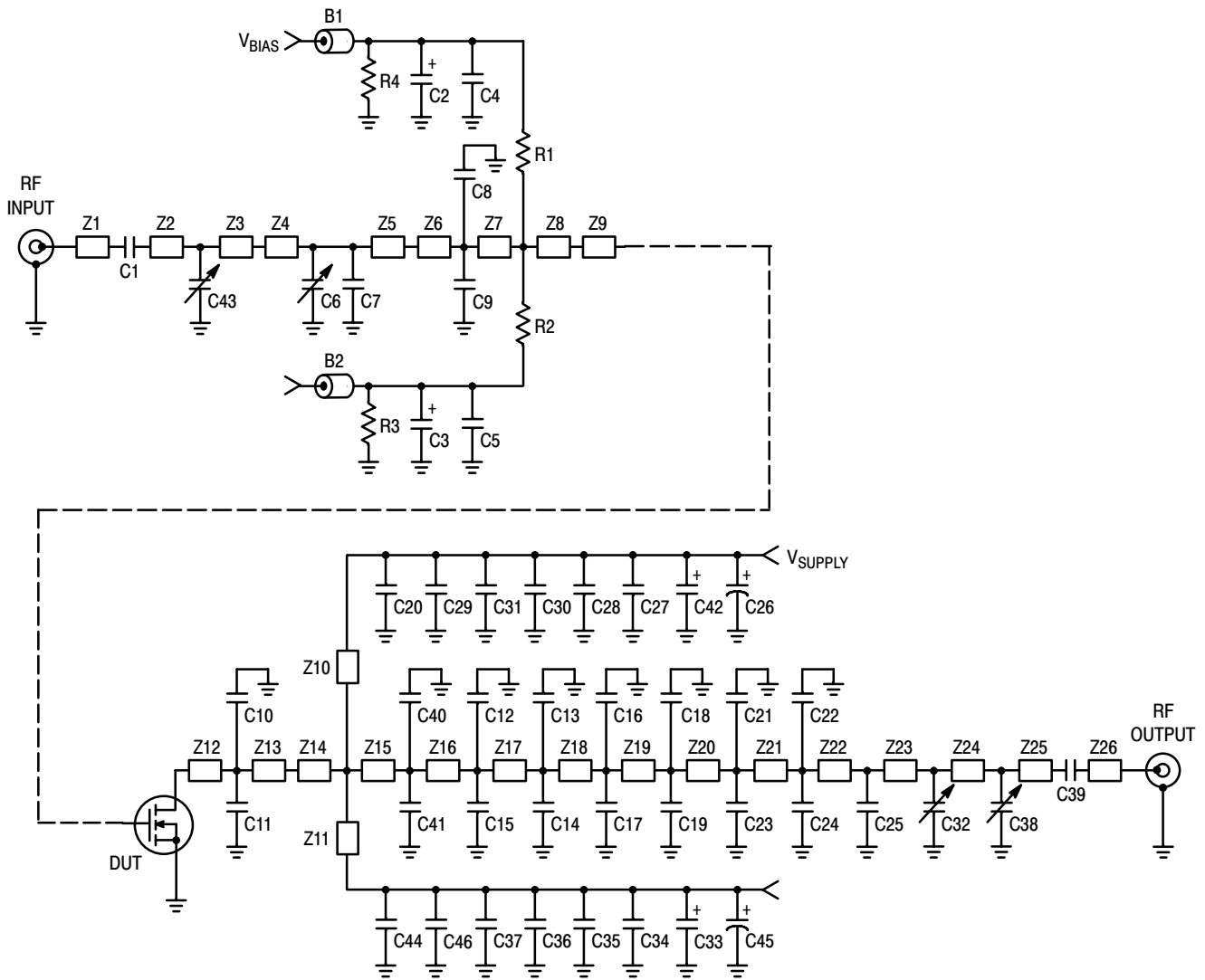
Power Gain	$G_{ps}$	19.5	20.8	22.5	dB
Drain Efficiency	$\eta_D$	29	31.3	—	%
Output Peak-to-Average Ratio @ 0.01% Probability on CCDF	PAR	7.7	8.1	—	dB
Adjacent Channel Power Ratio	ACPR	—	-46.5	-45	dBc
Input Return Loss	IRL	—	-16	-9	dB

1. Part is internally matched on input.

(continued)

**Table 4. Electrical Characteristics** ( $T_C = 25^\circ\text{C}$  unless otherwise noted) (continued)

Characteristic	Symbol	Min	Typ	Max	Unit
<b>Typical Performances</b> (In Freescale Test Fixture, 50 ohm system) $V_{DD} = 28\text{ Vdc}$ , $I_{DQ} = 1400\text{ mA}$ , 865-900 MHz Bandwidth					
Video Bandwidth @ 200 W PEP $P_{out}$ where $IM3 = -30\text{ dBc}$ (Tone Spacing from 100 kHz to VBW) $\Delta IMD3 = IMD3 @ \text{VBW frequency} - IMD3 @ 100\text{ kHz} < 1\text{ dBc}$ (both sidebands)	VBW	—	10	—	MHz
Gain Flatness in 35 MHz Bandwidth @ $P_{out} = 40\text{ W Avg.}$	$G_F$	—	0.19	—	dB
Average Deviation from Linear Phase in 35 MHz Bandwidth @ $P_{out} = 200\text{ W CW}$	$\Phi$	—	0.461	—	$^\circ$
Average Group Delay @ $P_{out} = 200\text{ W CW}$ , $f = 880\text{ MHz}$	Delay	—	11.66	—	ns
Part-to-Part Insertion Phase Variation @ $P_{out} = 200\text{ W CW}$ , $f = 880\text{ MHz}$ , Six Sigma Window	$\Delta\Phi$	—	14.97	—	$^\circ$
Gain Variation over Temperature ( $-30^\circ\text{C}$ to $+85^\circ\text{C}$ )	$\Delta G$	—	0.011	—	dB/ $^\circ\text{C}$
Output Power Variation over Temperature ( $-30^\circ\text{C}$ to $+85^\circ\text{C}$ )	$\Delta P_{1dB}$	—	0.39	—	dBm/ $^\circ\text{C}$

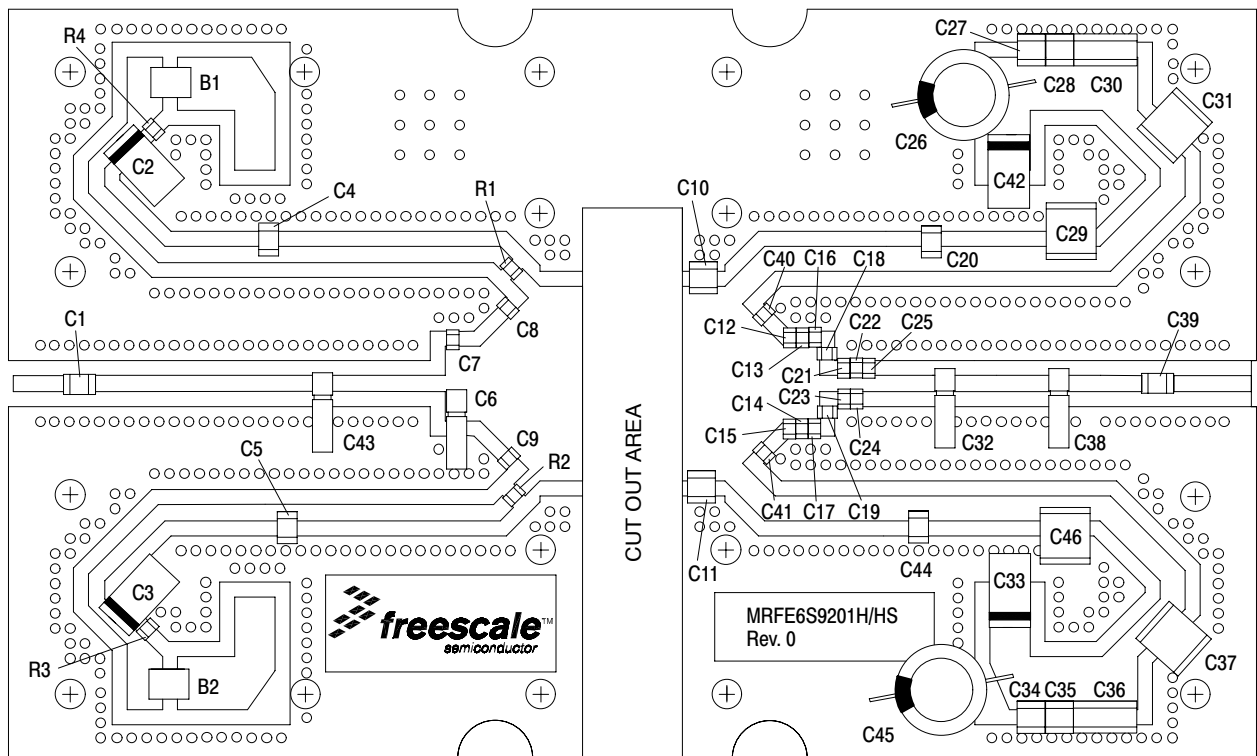


Z1	0.227" x 0.065" Microstrip	Z10, Z11	0.853" x 0.100" Microstrip	Z19	0.020" x 0.365" Microstrip
Z2	0.938" x 0.065" Microstrip	Z12	0.084" x 0.780" Microstrip	Z20	0.097" x 0.065" Microstrip
Z3	0.492" x 0.065" Microstrip	Z13	0.086" x 0.780" Microstrip	Z21, Z22	0.050" x 0.065" Microstrip
Z4	0.046" x 0.300" Microstrip	Z14	0.035" x 0.780" x 0.709" Taper	Z23	0.305" x 0.065" Microstrip
Z5	0.094" x 0.300" Microstrip	Z15	0.093" x 0.709" x 0.499" Taper	Z24	0.456" x 0.065" Microstrip
Z6	0.141" x 0.546" x 0.300" Taper	Z16	0.131" x 0.499" x 0.286" Taper	Z25	0.357" x 0.065" Microstrip
Z7	0.076" x 0.734" x 0.546" Taper	Z17	0.047" x 0.365" Microstrip	Z26	0.340" x 0.065" Microstrip
Z8	0.023" x 0.780" x 0.734" Taper	Z18	0.054" x 0.365" Microstrip	PCB	Taconic RF-35, 0.030", $\epsilon_r = 3.5$
Z9	0.170" x 0.780" Microstrip				

Figure 1. MRFE6S9201HR3(HSR3) Test Circuit Schematic

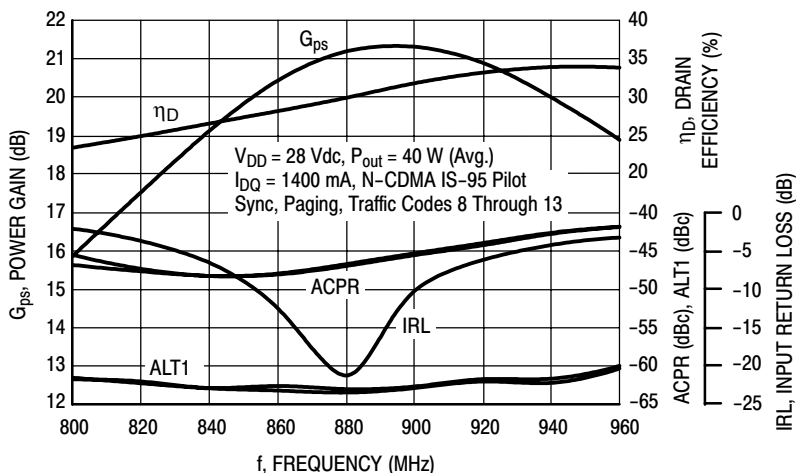
**Table 5. MRFE6S9201HR3(HSR3) Test Circuit Component Designations and Values**

Part	Description	Part Number	Manufacturer
B1, B2	Short RF Beads	2743019447ROP50	Fair-Rite
C1, C4, C5, C20, C39, C44	33 pF Chip Capacitors	ATC100B330JT500XT	ATC
C2, C3	10 $\mu$ F, 50 V Tantalum Capacitors	T491C106K050AT	Kemet
C6, C32, C38, C43	0.6 - 4.5 pF Variable Capacitors, Gigatrim	27271SL	Johanson
C7, C12, C13, C14, C15, C16, C17, C25	3.3 pF Chip Capacitors	ATC600F3R3BT250XT	ATC
C8, C9	4.7 pF Chip Capacitors	ATC600F4R7BT250XT	ATC
C10, C11	15 pF Chip Capacitors	ATC100B6R8JT500XT	ATC
C18, C19, C21, C22, C23, C24	1.0 pF Chip Capacitors	ATC600F1R0BT250XT	ATC
C26, C45	470 $\mu$ F, 63 V Electrolytic Capacitors	EKMG630ELL331MJ20S	United Chemi-Con
C27, C34	1.2K pF Chip Capacitors	ATC100B1R2BT500XT	ATC
C28, C35	20K pF Chip Capacitors	ATC200B203MT50XT	ATC
C29, C31, C37, C46	10 $\mu$ F, 50 V Chip Capacitors	GRM55DR61H106KA88B	Murata
C30, C36	0.047 pF, 50 V Chip Capacitors	C1825C473J5RAC	Kemet
C33, C42	22 $\mu$ F, 50 V Tantalum Capacitors	T491C226K050AT	Kemet
C40, C41	5.6 pF Chip Capacitors	ATC600F5R6BT250XT	ATC
R1, R2	12 $\Omega$ , 1/4 W Chip Resistors	CRCW120612R0FKEA	Vishay
R3, R4	1 K $\Omega$ , 1/4 W Chip Resistors	CRCW12061001FKEA	Vishay

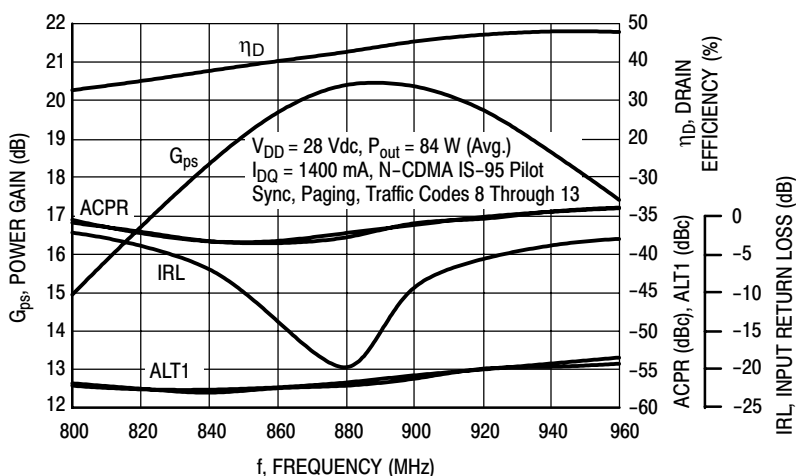


**Figure 2. MRFE6S9201HR3(HSR3) Test Circuit Component Layout**

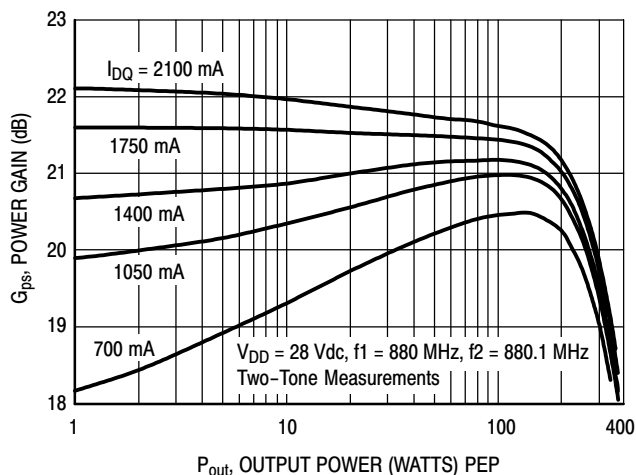
## TYPICAL CHARACTERISTICS



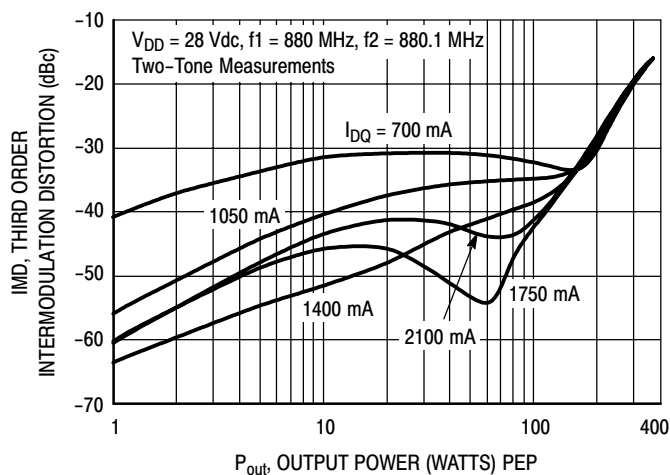
**Figure 3. Single-Carrier N-CDMA Broadband Performance @  $P_{out} = 40$  Watts Avg.**



**Figure 4. Single-Carrier N-CDMA Broadband Performance @  $P_{out} = 84$  Watts Avg.**



**Figure 5. Two-Tone Power Gain versus Output Power**



**Figure 6. Third Order Intermodulation Distortion versus Output Power**

## TYPICAL CHARACTERISTICS

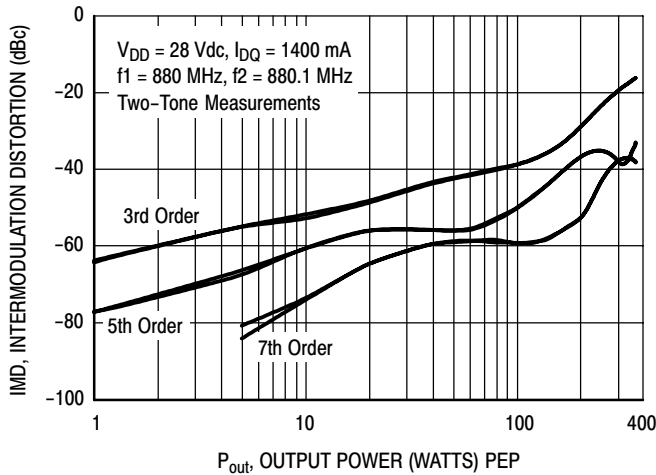


Figure 7. Intermodulation Distortion Products versus Output Power

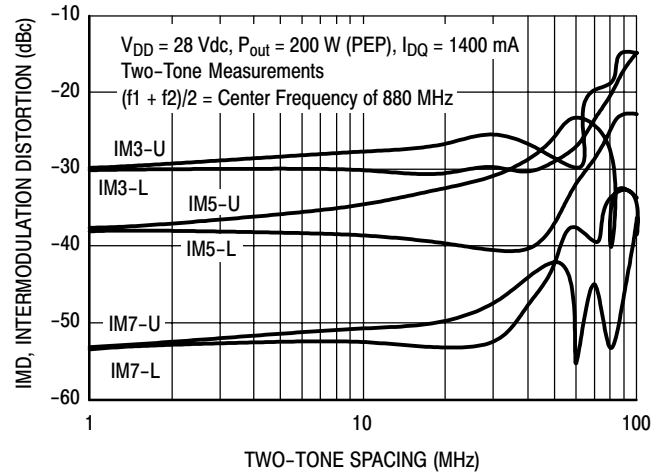


Figure 8. Intermodulation Distortion Products versus Tone Spacing

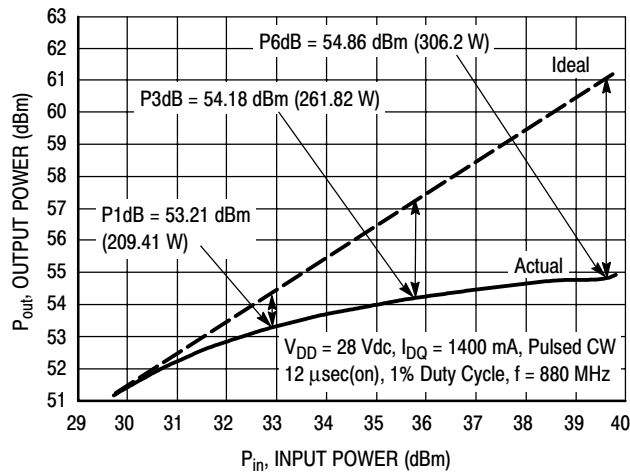


Figure 9. Pulsed CW Output Power versus Input Power

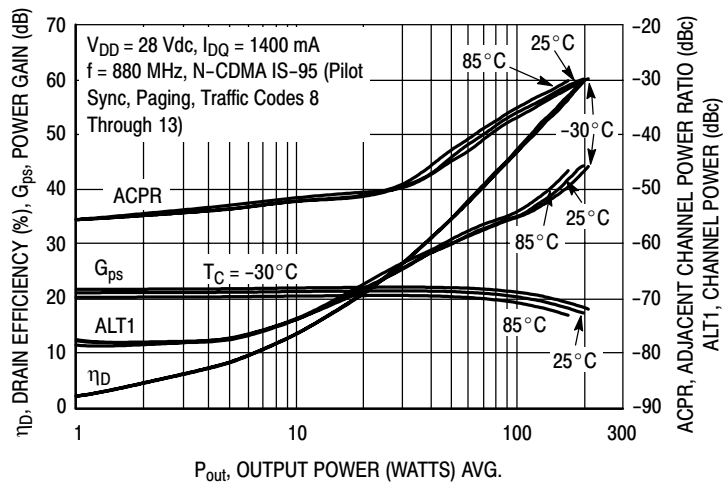
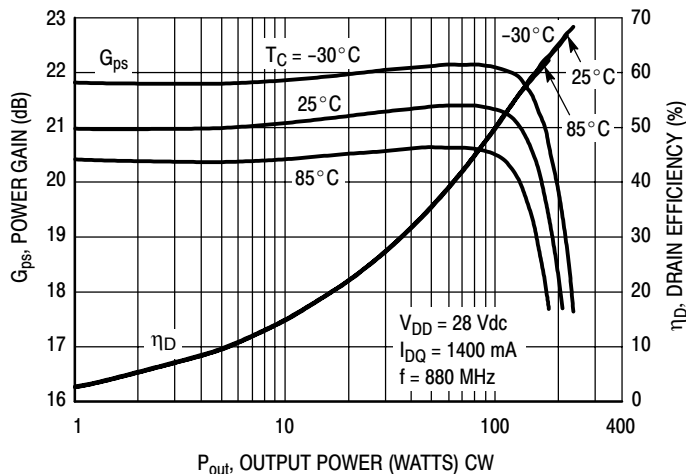
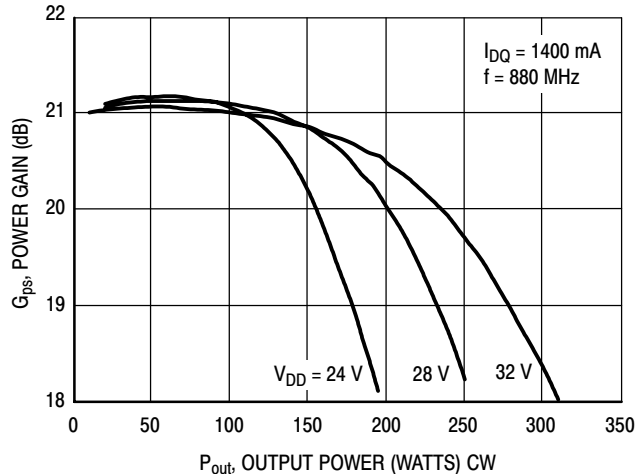


Figure 10. Single-Carrier N-CDMA ACPR, ALT1, Power Gain and Drain Efficiency versus Output Power

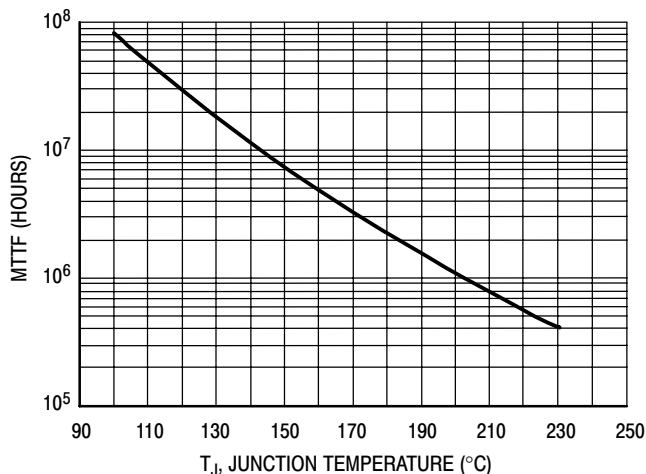
### TYPICAL CHARACTERISTICS



**Figure 11. Power Gain and Drain Efficiency versus CW Output Power**



**Figure 12. Power Gain versus Output Power**



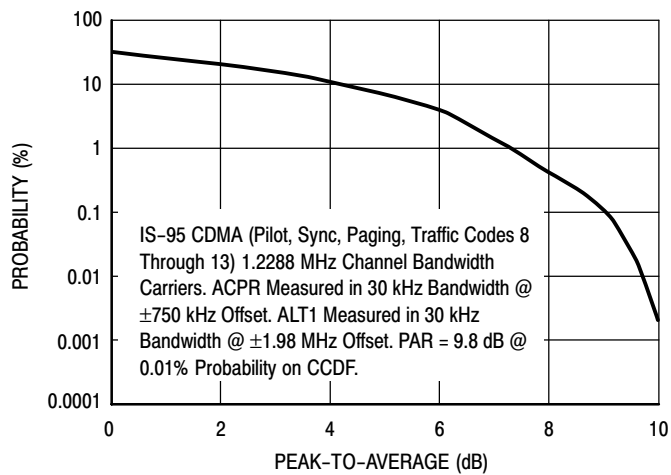
This above graph displays calculated MTTF in hours when the device is operated at  $V_{DD} = 28 \text{ Vdc}$ ,  $P_{out} = 40 \text{ W Avg.}$ , and  $\eta_D = 31.3\%$ .

MTTF calculator available at <http://www.freescale.com/rf>. Select Software & Tools/Development Tools/Calculators to access MTTF calculators by product.

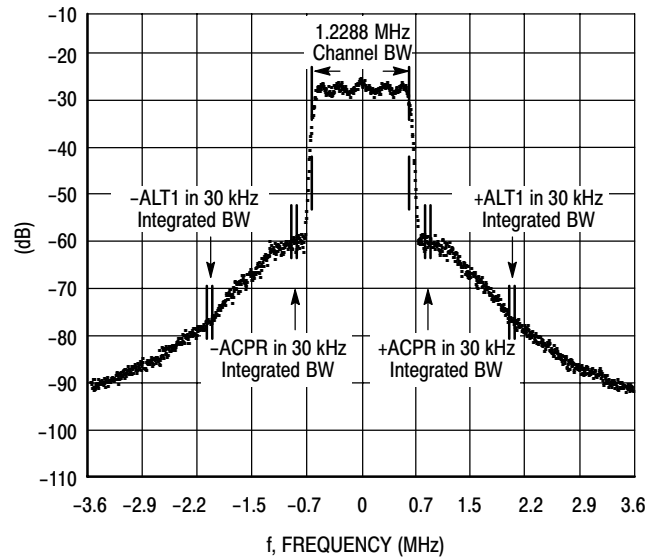
**Figure 13. MTTF versus Junction Temperature**



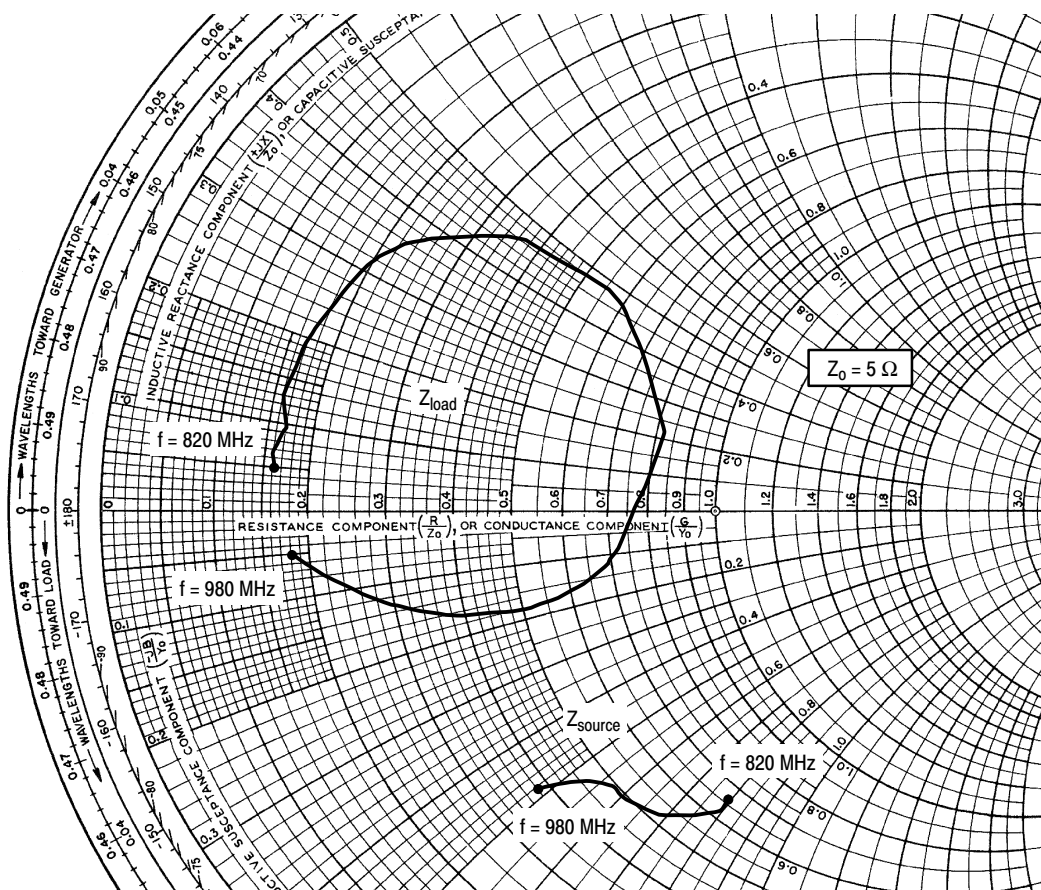
## N-CDMA TEST SIGNAL



**Figure 14. Single-Carrier CCDF N-CDMA**



**Figure 15. Single-Carrier N-CDMA Spectrum**



$V_{DD} = 28 \text{ Vdc}$ ,  $I_{DQ} = 1400 \text{ mA}$ ,  $P_{out} = 40 \text{ W Avg.}$

f MHz	$Z_{source}$ $\Omega$	$Z_{load}$ $\Omega$
820	$3.28 - j3.94$	$0.78 + j0.24$
840	$3.12 - j3.93$	$0.81 + j0.36$
860	$2.85 - j3.73$	$0.83 + j0.51$
880	$2.58 - j3.39$	$0.82 + j0.70$
900	$2.44 - j2.98$	$0.83 + j0.98$
920	$2.43 - j2.87$	$1.02 + j1.60$
940	$2.31 - j2.66$	$4.12 + j1.11$
960	$2.17 - j2.54$	$1.49 - j0.66$
980	$1.91 - j2.39$	$0.90 - j0.26$

$Z_{source}$  = Test circuit impedance as measured from gate to ground.

$Z_{load}$  = Test circuit impedance as measured from drain to ground.

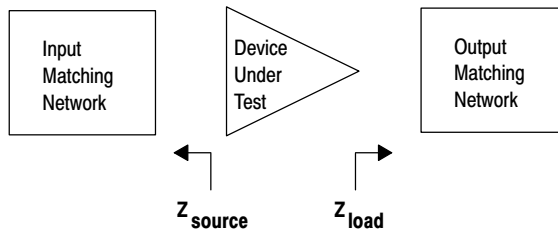
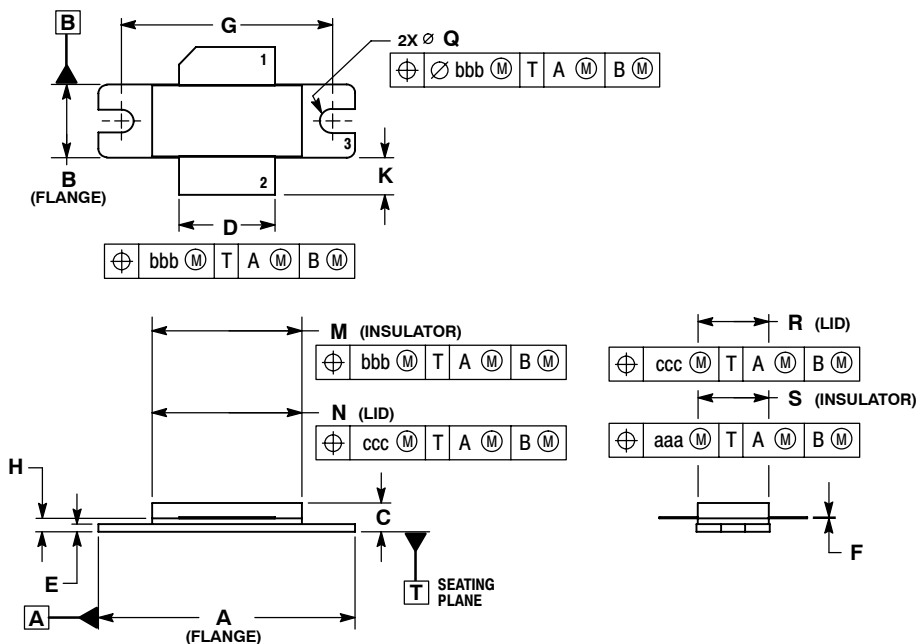


Figure 16. Series Equivalent Source and Load Impedance

## PACKAGE DIMENSIONS

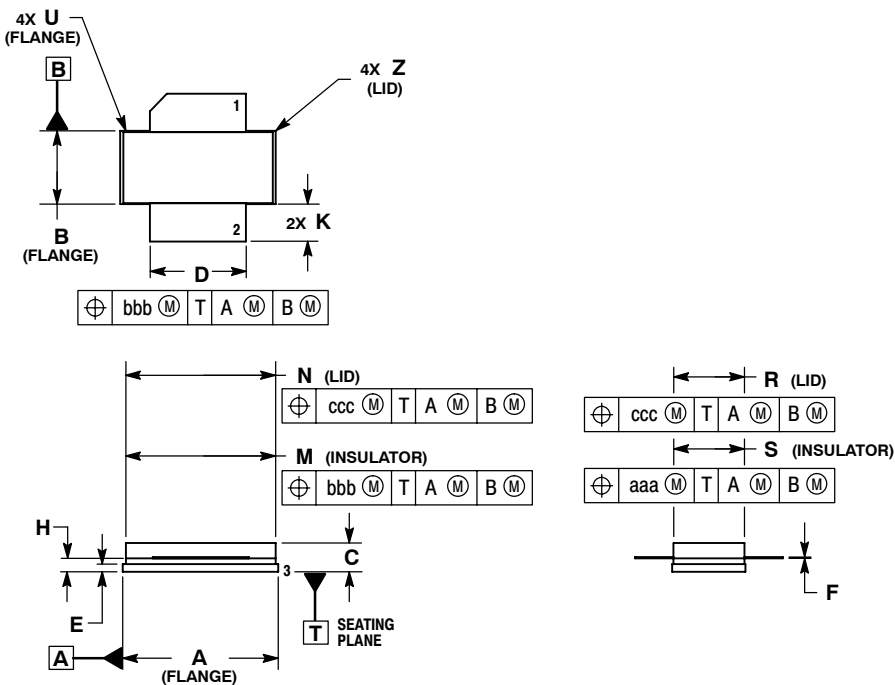


- NOTES:
1. DIMENSIONING AND TOLERANCING PER ANSI Y14.5M-1994.
  2. CONTROLLING DIMENSION: INCH.
  3. DELETED
  4. DIMENSION H IS MEASURED 0.030 (0.762) AWAY FROM PACKAGE BODY.

DIM	INCHES		MILLIMETERS	
	MIN	MAX	MIN	MAX
A	1.335	1.345	33.91	34.16
B	0.380	0.390	9.65	9.91
C	0.125	0.170	3.18	4.32
D	0.495	0.505	12.57	12.83
E	0.035	0.045	0.89	1.14
F	0.003	0.006	0.08	0.15
G	1.100 BSC		27.94 BSC	
H	0.057	0.067	1.45	1.70
K	0.170	0.210	4.32	5.33
M	0.774	0.786	19.66	19.96
N	0.772	0.788	19.60	20.00
Q	Ø 0.118	Ø 0.138	Ø 3.00	Ø 3.51
R	0.365	0.375	9.27	9.53
S	0.365	0.375	9.27	9.52
aaa	0.005 REF		0.127 REF	
bbb	0.010 REF		0.254 REF	
ccc	0.015 REF		0.381 REF	

- STYLE 1:  
 PIN 1. DRAIN  
 2. GATE  
 3. SOURCE

**CASE 465-06  
 ISSUE G  
 NI-780  
 MRFE6S9201HR3**



- NOTES:
1. DIMENSIONING AND TOLERANCING PER ANSI Y14.5M-1994.
  2. CONTROLLING DIMENSION: INCH.
  3. DELETED
  4. DIMENSION H IS MEASURED 0.030 (0.762) AWAY FROM PACKAGE BODY.

DIM	INCHES		MILLIMETERS	
	MIN	MAX	MIN	MAX
A	0.805	0.815	20.45	20.70
B	0.380	0.390	9.65	9.91
C	0.125	0.170	3.18	4.32
D	0.495	0.505	12.57	12.83
E	0.035	0.045	0.89	1.14
F	0.003	0.006	0.08	0.15
H	0.057	0.067	1.45	1.70
K	0.170	0.210	4.32	5.33
M	0.774	0.786	19.61	20.02
N	0.772	0.788	19.61	20.02
R	0.365	0.375	9.27	9.53
S	0.365	0.375	9.27	9.52
U	---	0.040	---	1.02
Z	---	0.030	---	0.76
aaa	0.005 REF		0.127 REF	
bbb	0.010 REF		0.254 REF	
ccc	0.015 REF		0.381 REF	

- STYLE 1:  
 PIN 1. DRAIN  
 2. GATE  
 5. SOURCE

**CASE 465A-06  
 ISSUE H  
 NI-780S  
 MRFE6S9201HSR3**

## PRODUCT DOCUMENTATION

Refer to the following documents to aid your design process.

### Application Notes

- AN1955: Thermal Measurement Methodology of RF Power Amplifiers

### Engineering Bulletins

- EB212: Using Data Sheet Impedances for RF LDMOS Devices

## REVISION HISTORY

The following table summarizes revisions to this document.

Revision	Date	Description
0	Sept. 2007	<ul style="list-style-type: none"><li>• Initial Release of Data Sheet</li></ul>
1	Dec. 2008	<ul style="list-style-type: none"><li>• Updated Typical Performance Full Frequency Band to <math>f = 880</math> MHz to match production test, p. 1</li><li>• Updated Part Numbers in Table 5, Component Designations and Values, to latest RoHS compliant part numbers, p. 5</li></ul>

## **How to Reach Us:**

### **Home Page:**

[www.freescale.com](http://www.freescale.com)

### **Web Support:**

<http://www.freescale.com/support>

### **USA/Europe or Locations Not Listed:**

Freescale Semiconductor, Inc.  
Technical Information Center, EL516  
2100 East Elliot Road  
Tempe, Arizona 85284  
1-800-521-6274 or +1-480-768-2130  
[www.freescale.com/support](http://www.freescale.com/support)

### **Europe, Middle East, and Africa:**

Freescale Halbleiter Deutschland GmbH  
Technical Information Center  
Schatzbogen 7  
81829 Muenchen, Germany  
+44 1296 380 456 (English)  
+46 8 52200080 (English)  
+49 89 92103 559 (German)  
+33 1 69 35 48 48 (French)  
[www.freescale.com/support](http://www.freescale.com/support)

### **Japan:**

Freescale Semiconductor Japan Ltd.  
Headquarters  
ARCO Tower 15F  
1-8-1, Shimo-Meguro, Meguro-ku,  
Tokyo 153-0064  
Japan  
0120 191014 or +81 3 5437 9125  
[support.japan@freescale.com](mailto:support.japan@freescale.com)

### **Asia/Pacific:**

Freescale Semiconductor China Ltd.  
Exchange Building 23F  
No. 118 Jianguo Road  
Chaoyang District  
Beijing 100022  
China  
+86 10 5879 8000  
[support.asia@freescale.com](mailto:support.asia@freescale.com)

### **For Literature Requests Only:**

Freescale Semiconductor Literature Distribution Center  
P.O. Box 5405  
Denver, Colorado 80217  
1-800-441-2447 or +1-303-675-2140  
Fax: +1-303-675-2150  
[LDCForFreescaleSemiconductor@hibbertgroup.com](mailto:LDCForFreescaleSemiconductor@hibbertgroup.com)

Information in this document is provided solely to enable system and software implementers to use Freescale Semiconductor products. There are no express or implied copyright licenses granted hereunder to design or fabricate any integrated circuits or integrated circuits based on the information in this document.

Freescale Semiconductor reserves the right to make changes without further notice to any products herein. Freescale Semiconductor makes no warranty, representation or guarantee regarding the suitability of its products for any particular purpose, nor does Freescale Semiconductor assume any liability arising out of the application or use of any product or circuit, and specifically disclaims any and all liability, including without limitation consequential or incidental damages. "Typical" parameters that may be provided in Freescale Semiconductor data sheets and/or specifications can and do vary in different applications and actual performance may vary over time. All operating parameters, including "Typicals" Microstrip, must be validated for each customer application by customer's technical experts. Freescale Semiconductor does not convey any license under its patent rights nor the rights of others. Freescale Semiconductor products are not designed, intended, or authorized for use as components in systems intended for surgical implant into the body, or other applications intended to support or sustain life, or for any other application in which the failure of the Freescale Semiconductor product could create a situation where personal injury or death may occur. Should Buyer purchase or use Freescale Semiconductor products for any such unintended or unauthorized application, Buyer shall indemnify and hold Freescale Semiconductor and its officers, employees, subsidiaries, affiliates, and distributors harmless against all claims, costs, damages, and expenses, and reasonable attorney fees arising out of, directly or indirectly, any claim of personal injury or death associated with such unintended or unauthorized use, even if such claim alleges that Freescale Semiconductor was negligent regarding the design or manufacture of the part.

Freescale™ and the Freescale logo are trademarks of Freescale Semiconductor, Inc. All other product or service names are the property of their respective owners.

© Freescale Semiconductor, Inc. 2007-2008. All rights reserved.

