

KEMET Part Number: LDBAA2220JC5N0
(DBAA2220JC5N0)

Capacitor, Film, Metallized PPS (Stacked), 0.022 uF, +/-5% Tol, General Purpose, 16 VDC@125C

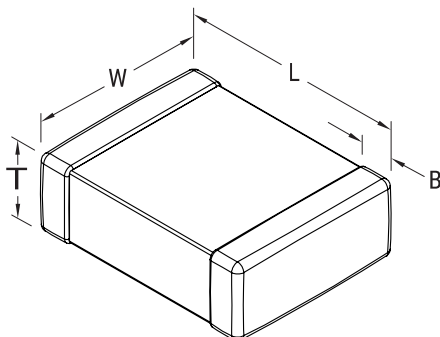

Dimensions (mm)		
Symbol	Dimension	Tolerance
L	3.3	+0.3/-0.1
W	1.7	+/-0.2
T	1.1	MAX
B	0.5	+0.5/-0.3

Packaging Specifications	
Package Kind:	T&R
Package Size:	Standard
Package Quantity:	3000

General Information	
Supplier:	KEMET
Dielectric:	Metallized PPS (Stacked)
Application:	General Purpose
Style:	Surface Mount
Chip Size:	1206 (3216 metric)
RoHS:	Yes

Specifications	
Capacitance:	0.022 uF
Voltage:	16 VDC
Tolerance:	+/-5%
Rated Temperature:	125C
Temperature Range:	-55/+125C
Dissipation Factor @ 1 kHz:	0.6%
Insulation Resistance:	3 GOhm