



500kHz, 36V Output, 600mW PWM Step-Up DC-DC Converter

MAX15032

General Description

The MAX15032 constant-frequency, pulse-width-modulating (PWM), low-noise boost converter is intended for low-voltage systems that need a locally generated high voltage. This device is capable of generating low-noise, high output voltages, with an output power capability up to 600mW with a 2.9V input voltage. This device can be used for a wide variety of applications, such as PIN or varactor diode biasing and LCD displays. The MAX15032 operates from +2.7V to +11V.

The constant-frequency (500kHz), current-mode PWM architecture provides low-noise output voltage that is easy to filter. A high-voltage internal lateral DMOS power switch allows this device to boost output voltages up to 36V. The MAX15032 features a shutdown mode to save power.

The MAX15032 is available in a small thermally enhanced 3mm x 3mm 8-pin TDFN package and is specified for operation over the -40°C to +125°C automotive temperature range.

Applications

Avalanche Photodiode Biasing
 PIN Diode Bias Supplies
 Low-Noise Varactor Diode Bias Supplies
 STB Audio IC Supplies
 LCD Displays

Pin Configuration

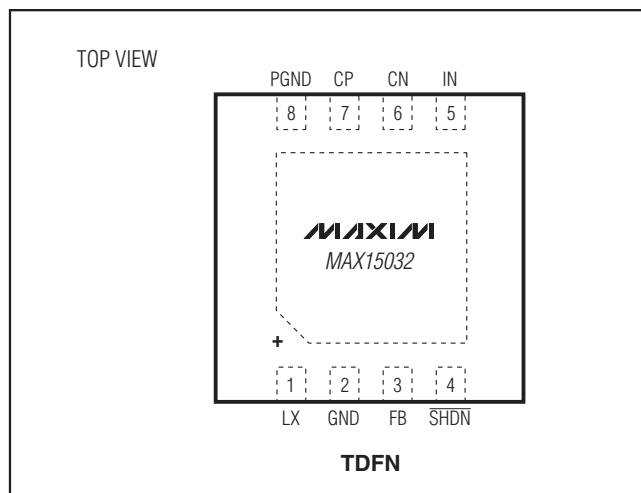

Features

- ◆ Input Voltage Range
 +2.7V to +5.5V (Using Internal Charge Pump)
 +5.5V to +11V
- ◆ Wide Adjustable Output Voltage Range: ($V_{IN} + 1V$) to 36V
- ◆ Output Power: $\geq 600mW$ for $V_{IN} \geq 2.9V$
- ◆ Internal 0.5Ω (typ), 40V Switch
- ◆ Constant PWM Frequency Provides Easy Filtering in Low-Noise Applications
- ◆ 500kHz (typ) Switching Frequency
- ◆ 0.5μA (max) Shutdown Current
- ◆ Internal Soft-Start
- ◆ Small Thermally Enhanced 3mm x 3mm 8-Pin TDFN Package

Ordering Information

PART	TEMP RANGE	PIN-PACKAGE	TOP MARK
MAX15032ATA+T	-40°C to +125°C	8 TDFN-EP*	+BKP

+Denotes a lead-free/RoHS-compliant package.

T = Tape and reel.

*EP = Exposed pad.

Typical Operating Circuit

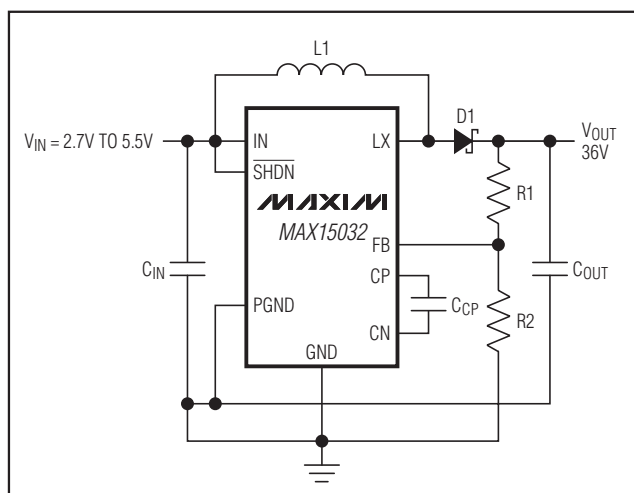

500kHz, 36V Output, 600mW PWM Step-Up DC-DC Converter

ABSOLUTE MAXIMUM RATINGS

IN to GND	-0.3V to +12V	Junction-to-Case Thermal Resistance (θ_{JC}) (Note 1)	8°C/W
LX to PGND	-0.3V to +40V	Junction-to-Ambient Thermal Resistance (θ_{JA}) (Note 1)	41°C/W
FB to GND	-0.3V to +12V	Operating Temperature Range	-40°C to +125°C
SHDN to GND	-0.3V to ($V_{IN} + 0.3V$)	Junction Temperature	+150°C
CN to GND	-0.3V to +12V	Storage Temperature Range	-65°C to +150°C
CP to GND	-0.3V to +12V	Lead Temperature (soldering, 10s)	+300°C
PGND to GND	-0.3V to +0.3V		
Continuous Power Dissipation ($T_A = +70^\circ\text{C}$)			
8-Pin TDFN (derate 24.4mW/°C above +70°C)	1951.2mW		

Note 1: Package thermal resistances were obtained using the method described in JEDEC specification JESD51-7, using a four-layer board. For detailed information on package thermal considerations, refer to www.maxim-ic.com/thermal-tutorial.

Stresses beyond those listed under "Absolute Maximum Ratings" may cause permanent damage to the device. These are stress ratings only, and functional operation of the device at these or any other conditions beyond those indicated in the operational sections of the specifications is not implied. Exposure to absolute maximum rating conditions for extended periods may affect device reliability.

ELECTRICAL CHARACTERISTICS

($V_{IN} = +3.3V$, $V_{SHDN} = +3.3V$, $C_{IN} = 10\mu\text{F}$, $\text{PGND} = \text{GND} = 0V$, $T_A = T_J = -40^\circ\text{C}$ to $+125^\circ\text{C}$, unless otherwise noted. Typical values are at $T_A = +25^\circ\text{C}$. See the *Typical Operating Circuit*.) (Note 2)

PARAMETER	SYMBOL	CONDITIONS		MIN	TYP	MAX	UNITS
SUPPLY VOLTAGE							
Supply Voltage Range	V_{IN}	$C_{CP} = 10\text{nF}$		2.7		5.5	V
		CP connected to IN		5.5		11	
Supply Current	I_{IN}	$V_{FB} = 1.4V$ (no switching), $C_{CP} = 10\text{nF}$, $V_{IN} = 3.3V$			1	2	mA
		$V_{FB} = 1.4V$ (no switching), CP = IN, $V_{IN} = 11V$			1.5	3	
Undervoltage Lockout	V_{UVLO}	V_{IN} rising		2.375	2.5	2.675	V
Undervoltage Lockout Hysteresis	$V_{UVLO-HYS}$				100		mV
Shutdown Current	I_{SHDN}	$V_{SHDN} = 0V$				0.5	μA
LOGIC INPUT ($\overline{\text{SHDN}}$)							
$\overline{\text{SHDN}}$ Input Low Level	V_{IL}					0.8	V
$\overline{\text{SHDN}}$ Input High Level	V_{IH}			2.0			V
BOOST CONVERTER							
Output Voltage Adjustment Range				$V_{IN} + 1$		36	V
Switching Frequency	f_{SW}			450	500	550	kHz
FB Set Point	V_{FB}			1.214	1.245	1.276	V
FB Input Bias Current	I_{FB}					300	nA
LX Switch On-Resistance	R_{DS_ON}	$C_{CP} = 10\text{nF}$, $I_{LX} = 100\text{mA}$	$V_{IN} = 2.9V$, $V_{CP} = 5.5V$		0.42	1	Ω
			$V_{IN} = 5.5V$, $V_{CP} = 10V$		0.33	1	
		CP connected to IN, $I_{LX} = 100\text{mA}$	$V_{IN} = V_{CP} = 5.5V$		0.42	1	
			$V_{IN} = V_{CP} = 11V$		0.33	1	
Peak Switch Current Limit	I_{LIM_LX}			1	1.33	1.7	A
LX Leakage Current		$V_{LX} = 36V$				2	μA
Line Regulation		$I_{LOAD} = 2\text{mA}$			0.25		%

500kHz, 36V Output, 600mW PWM Step-Up DC-DC Converter

ELECTRICAL CHARACTERISTICS (continued)

($V_{IN} = +3.3V$, $V_{SHDN} = +3.3V$, $C_{IN} = 10\mu F$, $PGND = GND = 0V$, $T_A = T_J = -40^\circ C$ to $+125^\circ C$, unless otherwise noted. Typical values are at $T_A = +25^\circ C$. See the *Typical Operating Circuit*.) (Note 2)

PARAMETER	SYMBOL	CONDITIONS	MIN	TYP	MAX	UNITS
Load Regulation		$I_{LOAD} = 0$ to $20mA$, $V_{OUT} = 30V$		1		%
Soft-Start Duration				8		ms
Soft-Start Steps		$(0.25 \times I_{LIM_LX})$ to I_{LIM_LX}		32		Steps
THERMAL PROTECTION						
Thermal Shutdown		Rising		+160		$^\circ C$
Thermal-Shutdown Hysteresis				8		$^\circ C$

Note 2: All devices are 100% production tested at room temperature ($T_A = +25^\circ C$). All parameter limits through the temperature range are guaranteed by design.

Typical Operating Characteristics

($V_{IN} = 3.3V$, $L1 = 4.7\mu H$, $R1 = 143k\Omega$, $R2 = 6.2k\Omega$, $C_{IN} = 10\mu F$, $C_{OUT} = 2.2\mu F$, $C_{CP} = 10nF$, see the *Typical Operating Circuit*. $T_A = +25^\circ C$, unless otherwise noted.)

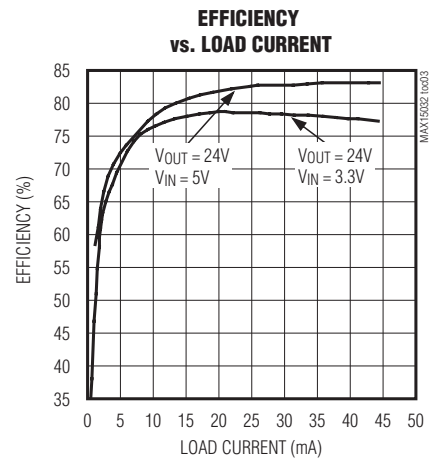
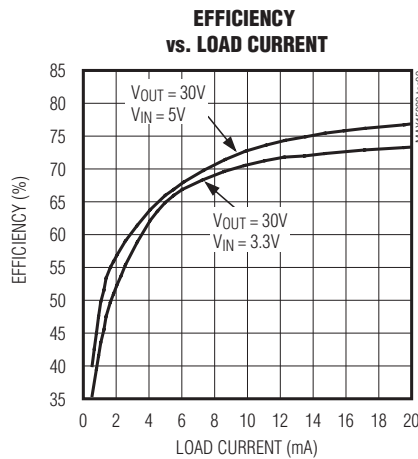
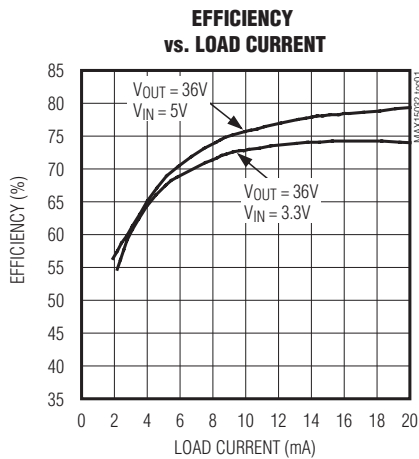

500kHz, 36V Output, 600mW PWM Step-Up DC-DC Converter

Typical Operating Characteristics (continued)

($V_{IN} = 3.3V$, $L_1 = 4.7\mu H$, $R_1 = 143k\Omega$, $R_2 = 6.2k\Omega$, $C_{IN} = 10\mu F$, $C_{OUT} = 2.2\mu F$, $C_{CP} = 10nF$, see the *Typical Operating Circuit*. $T_A = +25^\circ C$, unless otherwise noted.)

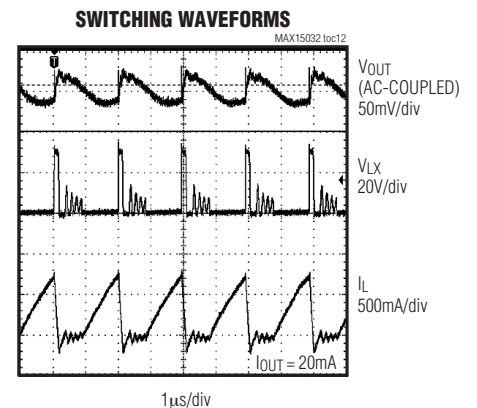
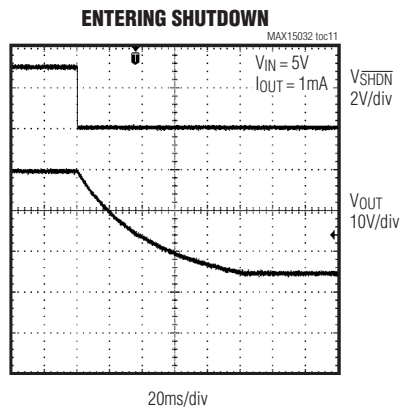
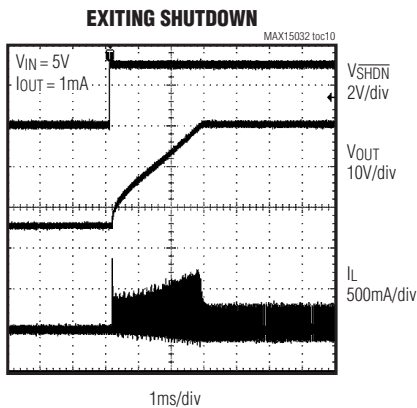
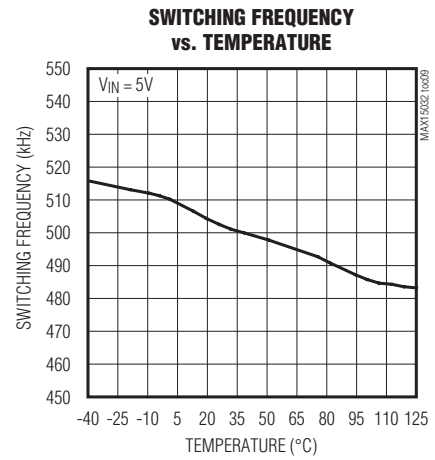
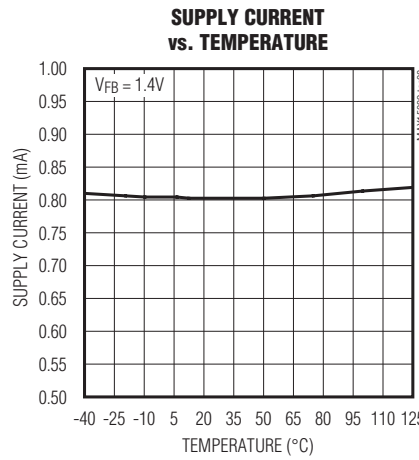
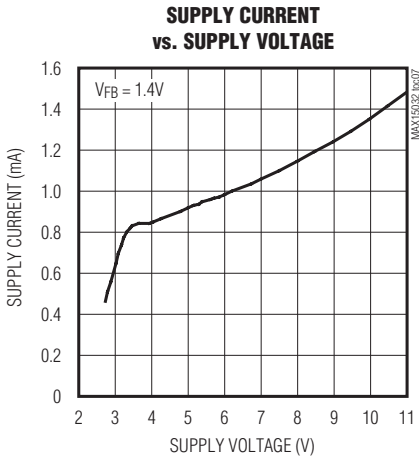
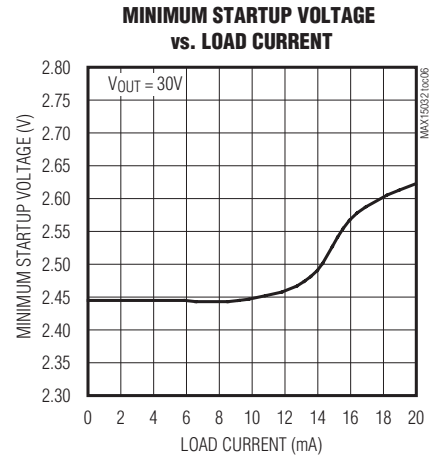
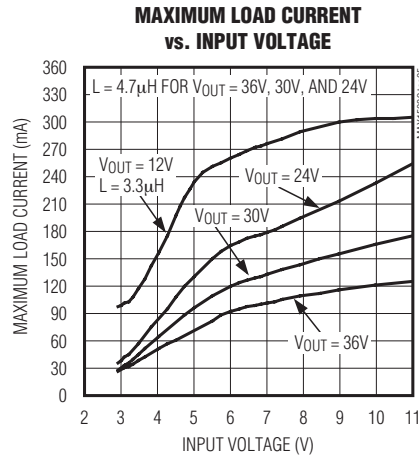
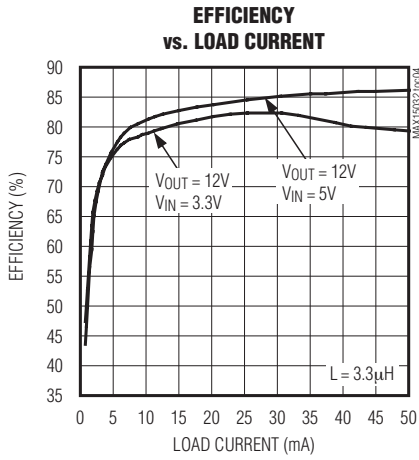

500kHz, 36V Output, 600mW PWM Step-Up DC-DC Converter

MAX15032

Typical Operating Characteristics (continued)

($V_{IN} = 3.3V$, $L_1 = 4.7\mu H$, $R_1 = 143k\Omega$, $R_2 = 6.2k\Omega$, $C_{IN} = 10\mu F$, $C_{OUT} = 2.2\mu F$, $C_{CP} = 10nF$, see the *Typical Operating Circuit*. $T_A = +25^\circ C$, unless otherwise noted.)

LOAD-TRANSIENT RESPONSE

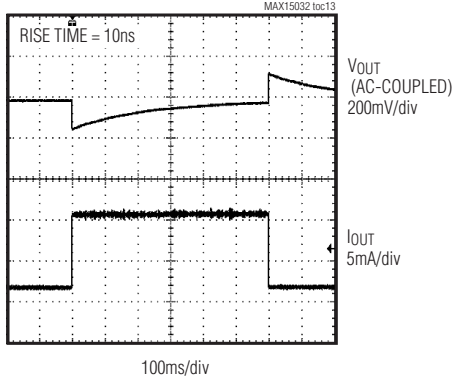

LINE-TRANSIENT RESPONSE

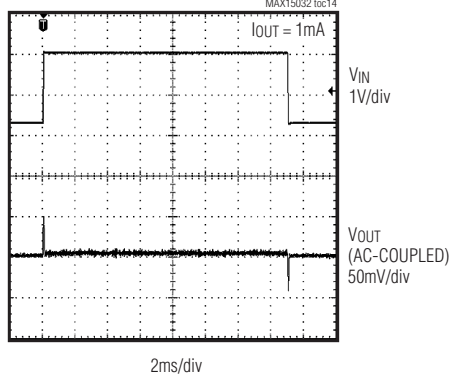

FB VOLTAGE vs. TEMPERATURE

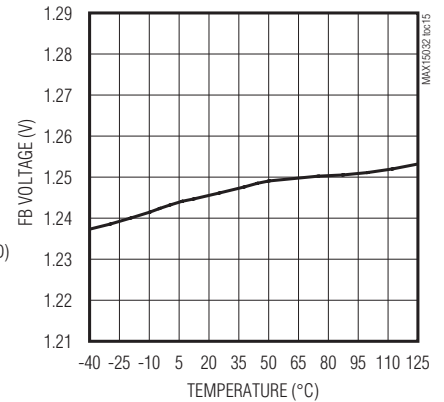

SWITCH ON-RESISTANCE vs. TEMPERATURE

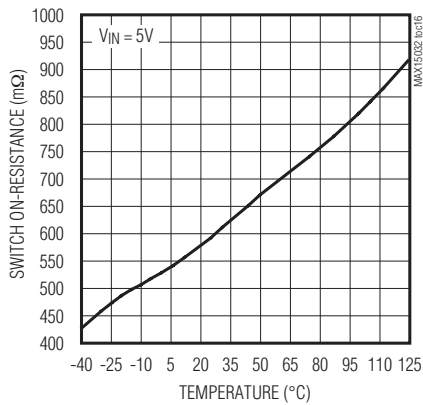

LX LEAKAGE CURRENT vs. TEMPERATURE

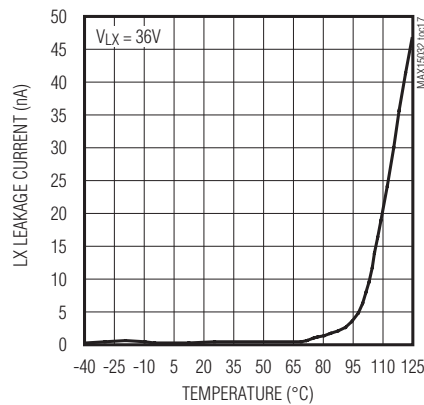

SHUTDOWN SUPPLY CURRENT vs. TEMPERATURE

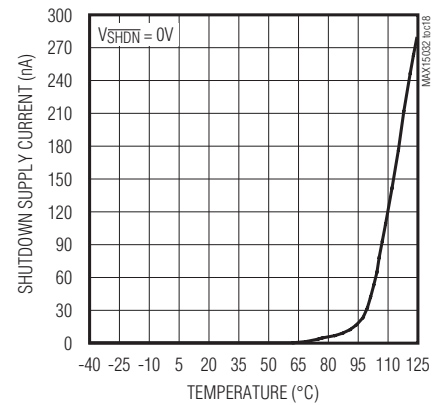

OUTPUT VOLTAGE vs. LOAD CURRENT

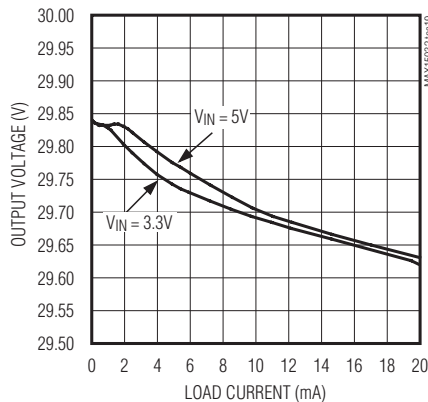

VOUT vs. OPTIMUM INDUCTOR VALUE

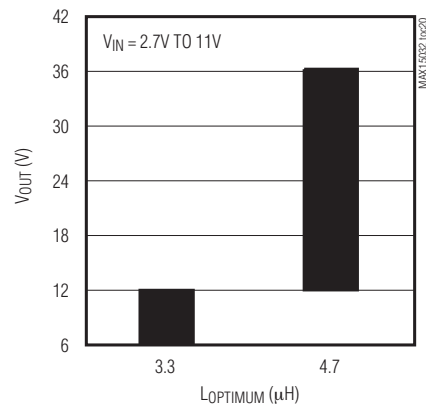

500kHz, 36V Output, 600mW PWM Step-Up DC-DC Converter

Pin Description

PIN	NAME	FUNCTION
1	LX	Drain of Internal 40V n-Channel DMOS. Connect inductor/diode to LX. Minimize trace area at LX to reduce switching noise emission.
2	GND	Signal Ground. Connect directly to the local ground plane. Connect GND to PGND at a single point, typically near the output capacitor return terminal.
3	FB	Feedback Regulation Point. Connect to the center tap of a resistive divider from the output (V_{OUT}) to GND to set the output voltage. The FB voltage regulates to 1.245V (typ).
4	$\overline{\text{SHDN}}$	Active-Low Shutdown Control Input. A logic-low voltage on $\overline{\text{SHDN}}$ shuts down the device and reduces the supply current to 0.5 μA (max). Connect $\overline{\text{SHDN}}$ to IN for always-on operation. Do not connect $\overline{\text{SHDN}}$ to a voltage higher than V_{IN} .
5	IN	Input Supply Voltage. Bypass IN to PGND with a 4.7 μF minimum ceramic capacitor.
6	CN	Negative Terminal of the Charge-Pump Flying Capacitor for 2.7V to 5.5V Supply Voltage Operation. Leave CN unconnected when the input voltage is in the +5.5V to +11V range.
7	CP	Positive Terminal of the Charge-Pump Flying Capacitor for 2.7V to 5.5V Supply Voltage Operation. Connect to IN when the input voltage is in the +5.5V to +11V range.
8	PGND	Power Ground. Connect the input and output filter capacitors' negative terminal to PGND. Connect externally to GND at a single point, typically at the output capacitor return terminal.
—	EP	Exposed Pad. Connect EP to a large copper plane at the GND potential to improve thermal dissipation. Do not use as the main GND connection.

Functional Diagram

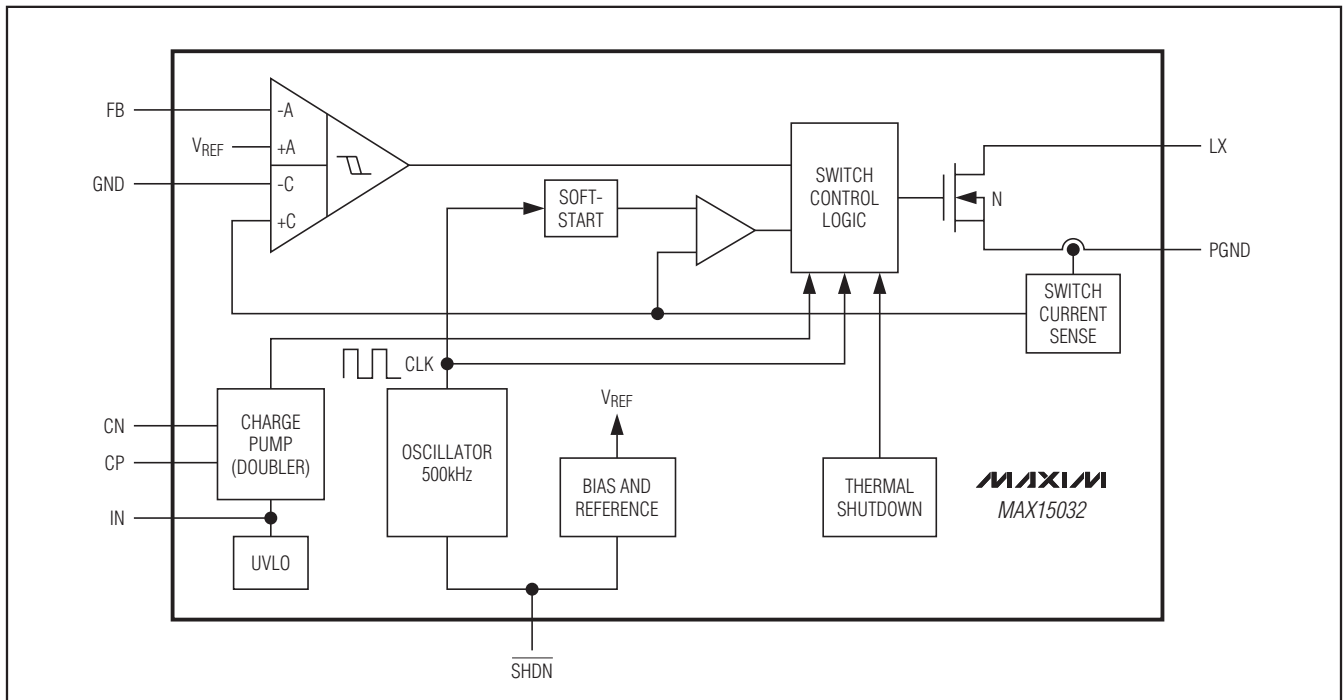

500kHz, 36V Output, 600mW PWM Step-Up DC-DC Converter

Detailed Description

The MAX15032 constant-frequency, current-mode, pulse-width-modulating (PWM) boost converter is intended for low-voltage systems that often need a locally generated high voltage. This device is capable of generating low-noise, high-output voltage required for PIN and varactor diode biasing and LCD displays. The MAX15032 operates either from +2.7V to +5.5V or from +5.5V to +11V. For +2.7V to +5.5V operation, an internal charge pump with an external 10nF ceramic capacitor is used. The MAX15032 also features a shutdown logic input to disable the device and reduce its standby current to 0.5 μ A (max).

The MAX15032 operates in discontinuous mode in order to reduce the switching noise caused by the reverse recovery charge of the rectifier diode. Other continuous mode boost converters generate large voltage spikes at the output when the LX switch turns on because there is a conduction path between the output, diode, and switch to ground during the time needed for the diode to turn off and reverse its bias voltage. To reduce the output noise even further, the LX switch turns off by taking 6.8ns typically to transition from "ON" to "OFF." As a consequence, the positive slew rate of the LX node is reduced and the current from the inductor does not "force" the output voltage as hard as would be the case if the LX switch were to turn off more quickly.

Also, the constant-frequency (500kHz) PWM architecture generates an output voltage ripple that is easy to filter. A 40V lateral DMOS device used as the internal power switch makes the device ideal for boost converters with output voltages up to 36V.

The MAX15032 can also be used in other topologies where the PWM switch is grounded, like SEPIC and flyback.

PWM Controller

The heart of the MAX15032 current-mode PWM controller is a BiCMOS multi-input comparator that simultaneously processes the output-error signal and switch current signal. The main PWM comparator is direct summing, lacking a traditional error amplifier and its associated phase shift. The direct summing configura-

tion approaches ideal cycle-by-cycle control over the output voltage since there is no conventional error amplifier in the feedback path.

The device operates in PWM mode using a fixed-frequency, current-mode operation. The current-mode frequency loop regulates the peak inductor current as a function of the output error signal. The current-mode PWM controller is intended for discontinuous conduction mode (DCM) operation. No internal slope compensation is added to the current signal.

Shutdown (SHDN)

The MAX15032 features an active-low shutdown input ($\overline{\text{SHDN}}$). Pull $\overline{\text{SHDN}}$ low to enter shutdown. During shutdown, the supply current drops to 0.5 μ A (max). However, the output remains connected to the input through the inductor and output rectifier, holding the output voltage to one diode drop below V_{IN} when the MAX15032 shuts down. Connect $\overline{\text{SHDN}}$ to IN for always-on operation.

Charge Pump

At low supply voltages (+2.7V to +5.5V), an internal charge-pump circuit and an external 10nF ceramic capacitor double the available supply voltage in order to drive the internal switch efficiently.

In the +5.5V to +11V supply voltage range, the charge pump must be disabled by connecting CP to IN and leaving CN unconnected.

Design Procedure

Setting the Output Voltage

Set the MAX15032 output voltage by connecting a resistive divider from the output to FB to GND (see the *Typical Operating Circuit*). Select R2 (FB to GND resistor) between 6k Ω and 10k Ω . Calculate R1 (V_{OUT} to FB resistor) with the following equation:

$$R1 = R2 \left[\left(\frac{V_{\text{OUT}}}{V_{\text{FB}}} \right) - 1 \right]$$

where $V_{\text{FB}} = 1.245\text{V}$ (see the *Electrical Characteristics* table) and V_{OUT} can range from ($V_{\text{IN}} + 1\text{V}$) to 36V.

500kHz, 36V Output, 600mW PWM Step-Up DC-DC Converter

Determining Peak Inductor Current

If the boost converter remains in the discontinuous mode of operation, then the approximate peak inductor current, I_{LPEAK} (A), is represented by the formula below:

$$I_{LPEAK} = \sqrt{\frac{2 \times T_S \times (V_{OUT} - V_{IN_MIN}) \times I_{OUT}}{\eta \times L}}$$

where T_S is the period in μs , V_{OUT} is the output voltage in volts, V_{IN_MIN} is the minimum input voltage in volts, I_{OUT} is the output current in amperes, L is the inductor value in μH , and η is the efficiency of the boost converter.

Determining the Inductor Value

Three key inductor parameters must be specified for operation with the MAX15032: inductance value (L), inductor saturation current (I_{SAT}), and DC series resistance (DCR). In general, the inductor should have a saturation current rating greater than the maximum switch peak current-limit value ($I_{LIM-LX(MAX)} = 1.7A$). DCR should be below 0.1Ω for reasonable efficiency. Due to the high switching frequency of the MAX15032, inductors with a ferrite core or equivalent are recommended to minimize core losses. Table 1 shows a list of vendors with $4.7\mu H$ inductor parts.

Table 1. Inductor Vendors

VENDOR	PHONE	FAX	PART NUMBER OF 4.7 μH INDUCTOR
TDK	408-437-9585	408-437-9591	SLF7045T-4R7M2R0-PF
TOKO	847-297-0070	847-699-7864	636CY-4R7M+P3
Coilcraft	800-322-2645	847-639-1469	MOS6020-472MLC

Use the following formula to calculate the lower bound of the inductor value at different output voltages and output currents. This is the minimum inductance value for discontinuous mode operation for supplying the full 600mW output power:

$$L_{MIN}[\mu H] = \frac{2 \times T_S \times I_{OUT} \times (V_{OUT} - V_{IN_MIN})}{\eta \times I_{LIM-LX}^2}$$

where V_{IN} (V), V_{OUT} (V), and I_{OUT} (A) are typical values, T_S (μs) is the period, η is the efficiency, and I_{LIM-LX} is the peak LX current (A).

Calculate the optimum value of L ($L_{OPTIMUM}$) to ensure the full output power without reaching the boundary between continuous conduction mode (CCM) and DCM using the following formula:

$$L_{OPTIMUM} = \frac{L_{MAX}[\mu H]}{2.25}$$

where:

$$L_{MAX}[\mu H] = \frac{V_{IN_MIN}^2 (V_{OUT} - V_{IN_MIN}) \times T_S \times \eta}{2 \times I_{OUT} \times V_{OUT}^2}$$

For a design in which $V_{IN} = 3.3V$, $V_{OUT} = 30V$, $I_{OUT} = 20mA$, $\eta = 0.7$, and $T_S = 2\mu s$, $L_{OPTIMUM} = 4.7\mu H$:

$$L_{MAX} = 10.5\mu H$$

and

$$L_{MIN} = 3.3\mu H$$

For a worst-case scenario in which $V_{IN} = 2.9V$, $V_{OUT} = 30V$, $I_{OUT} = 20mA$, $\eta = 0.7$, $I_{LIM-LX(MIN)} = 1A$, and $T_S = 1.8\mu s$:

$$L_{MAX} = 9.2\mu H$$

and:

$$L_{MIN} = 2.2\mu H$$

The choice of $4.7\mu H$ is reasonable given the worst-case scenario above. In general, the higher the inductance, the lower the switching noise.

Diode Selection

The MAX15032's high switching frequency demands a high-speed rectifier. Schottky diodes are recommended for most applications because of their fast recovery time and low forward-voltage drop. Ensure that the diode's peak current rating is greater than the inductor peak current. Also, the diode reverse breakdown voltage must be greater than V_{OUT} .

Output Filter Capacitor Selection

For most applications, use a small ceramic surface-mount output capacitor, $2.2\mu F$ or greater. To achieve low output ripple, a capacitor with low-ESR, low-ESL, and high-capacitance value should be selected. If tantalum or electrolytic capacitors are used to achieve high capacitance values, always add a small ceramic in parallel to bypass the high-frequency components of the diode current. The higher ESR and ESL of electrolytic increase both the output ripple and peak-to-peak transient voltage. Assuming the contribution from the ESR and capacitor

500kHz, 36V Output, 600mW PWM Step-Up DC-DC Converter

discharge equals 50% (proportions could vary), calculate the output capacitance and ESR required for a specified ripple using the following equations:

$$C_{OUT}[\mu F] = \frac{I_{OUT}}{0.5 \times \Delta V_{OUT}} \left[T_S - \frac{I_{LPEAK} \times L_{OPTIMUM}}{(V_{OUT} - V_{IN_MIN})} \right]$$

$$ESR[m\Omega] = \frac{0.5 \times \Delta V_{OUT}}{I_{OUT}}$$

For very low output-ripple applications, the output of the boost converter can be followed by an RC filter to further reduce the ripple. Figure 1 shows a 10Ω, 2.2μF filter used to reduce the switching output ripple to 1mVp-p with a 20mA output and a ripple voltage of 400μVp-p with a 2mA load. The output voltage regulation resistive divider must remain connected to the diode/output capacitor node.

X7R ceramic capacitors are stable over -40°C to +125°C temperature range. Where the automotive temperature range is required, use X7R ceramic capacitors. X5R dielectric can be used for -40°C to +85°C applications.

Input Capacitor Selection

Bypass IN (the input voltage pin) to PGND with a minimum 4.7μF ceramic capacitor. Depending on the supply source impedance, higher values might be needed. Make sure that the input capacitor is close enough to the IC to provide adequate decoupling at IN as well. If the layout cannot achieve this, add another 0.1μF ceramic capacitor between IN and PGND in the immediate vicinity of the IC. Bulk aluminum electrolytic capacitors might be needed to avoid chattering at low input voltages. In the case of aluminum electrolytic capacitors, calculate the capacitor value and ESR of the input capacitor using the following equations:

diode vicinity of the IC. Bulk aluminum electrolytic capacitors might be needed to avoid chattering at low input voltages. In the case of aluminum electrolytic capacitors, calculate the capacitor value and ESR of the input capacitor using the following equations:

$$C_{IN}[\mu F] = \frac{V_{OUT} \times I_{OUT}}{\eta \times V_{IN_MIN} \times 0.5 \times \Delta V_{IN}} \left[T_S - \frac{I_{LPEAK} \times L_{OPTIMUM} \times V_{OUT}}{V_{IN_MIN}(V_{OUT} - V_{IN_MIN})} \right]$$

$$ESR[m\Omega] = \frac{0.5 \times \Delta V_{IN} \times \eta \times \Delta V_{IN_MIN}}{V_{OUT} \times I_{OUT}}$$

Applications Information

Layout Considerations

Careful PCB layout is critical to achieve clean and stable operation. Protect sensitive analog grounds by using a star ground configuration. Connect GND and PGND together close to the device at the return terminal of the output bypass capacitor. Do not connect them together anywhere else. Keep all PCB traces as short as possible to reduce stray capacitance, trace resistance, and radiated noise. Ensure that the feedback connection to FB is short and direct. Route high-speed switching nodes away from the sensitive analog areas. Avoid any coupling from LX to FB node by keeping the FB node away from the LX routing. In addition, decoupling LX and FB with a small 22pF capacitor from FB to GND can be used. Use an internal PCB layer for GND as an EMI shield to keep radiated noise away from the device, feedback dividers, and bypass capacitors.

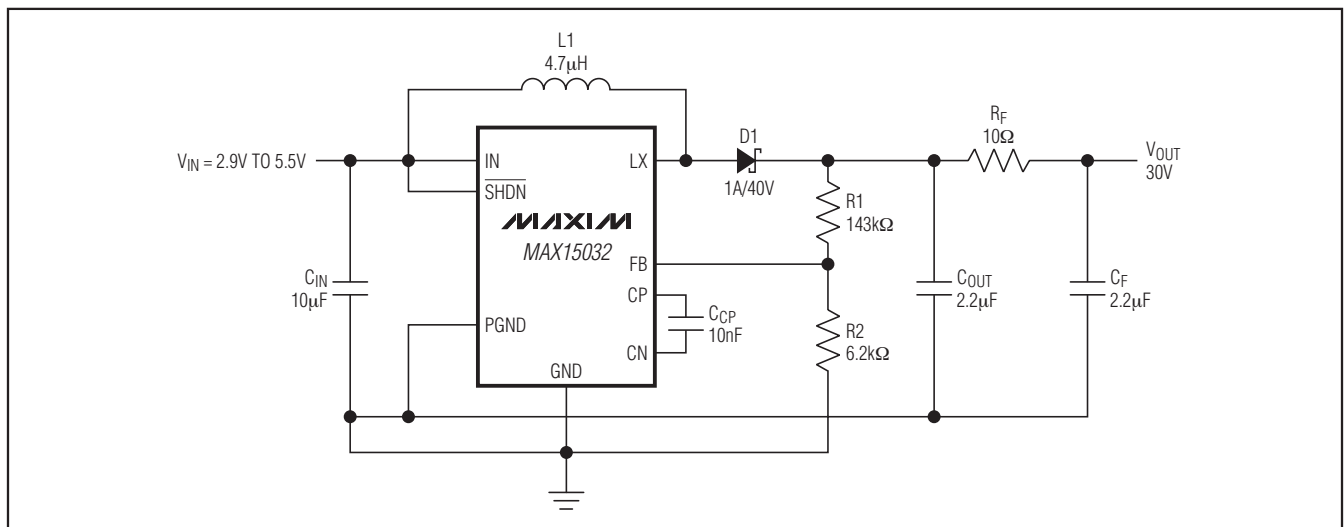

Figure 1. Typical Operating Circuit with RC Filter

500kHz, 36V Output, 600mW PWM Step-Up DC-DC Converter

Chip Information

PROCESS: BICMOS

Package Information

For the latest package outline information and land patterns, go to www.maxim-ic.com/packages.

PACKAGE TYPE	PACKAGE CODE	DOCUMENT NO.
8 TDFN	T833-2	21-0137

Maxim cannot assume responsibility for use of any circuitry other than circuitry entirely embodied in a Maxim product. No circuit patent licenses are implied. Maxim reserves the right to change the circuitry and specifications without notice at any time.

10 **Maxim Integrated Products, 120 San Gabriel Drive, Sunnyvale, CA 94086 408-737-7600**