

# XPT IGBT

preliminary

$$V_{CES} = 1200V$$

$$I_{C25} = 20A$$

$$V_{CE(sat)} = 1.8V$$

Copack

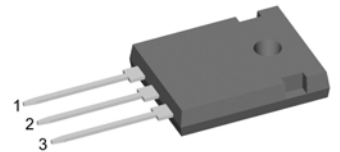
**Part number**
**IXA12IF1200HB**

Backside: collector

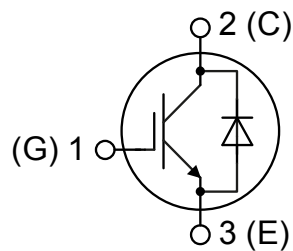
**Features / Advantages:**

- Easy paralleling due to the positive temperature coefficient of the on-state voltage
- Rugged XPT design (Xtreme light Punch Through) results in:
  - short circuit rated for 10  $\mu$ sec.
  - very low gate charge
  - low EMI
  - square RBSOA @ 3x  $I_c$
- Thin wafer technology combined with the XPT design results in a competitive low  $V_{CE(sat)}$
- SONIC™ diode
  - fast and soft reverse recovery
  - low operating forward voltage

**Applications:**

- AC motor drives
- Solar inverter
- Medical equipment
- Uninterruptible power supply
- Air-conditioning systems
- Welding equipment
- Switched-mode and resonant-mode power supplies
- Inductive heating, cookers
- Pumps, Fans

**Package: TO-247**

- Industry standard outline
- RoHS compliant
- Epoxy meets UL 94V-0

IGBT				Ratings			
Symbol	Definition	Conditions	min.	typ.	max.	Unit	
$V_{CES}$	collector emitter voltage	$T_{VJ} = 25^{\circ}\text{C}$			1200	V	
$V_{GES}$	max. DC gate voltage				$\pm 20$	V	
$V_{GEM}$	max. transient gate emitter voltage				$\pm 30$	V	
$I_{C25}$	collector current	$T_C = 25^{\circ}\text{C}$			20	A	
$I_{C100}$		$T_C = 100^{\circ}\text{C}$			13	A	
$P_{tot}$	total power dissipation	$T_C = 25^{\circ}\text{C}$			85	W	
$V_{CE(sat)}$	collector emitter saturation voltage	$I_C = 10\text{A}; V_{GE} = 15\text{V}$		1.8	2.1	V	
				2.1		V	
$V_{GE(th)}$	gate emitter threshold voltage	$I_C = 0.3\text{mA}; V_{GE} = V_{CE}$	5.4	5.9	6.5	V	
$I_{CES}$	collector emitter leakage current	$V_{CE} = V_{CES}; V_{GE} = 0\text{V}$			0.1	mA	
				0.1		mA	
$I_{GES}$	gate emitter leakage current	$V_{GE} = \pm 20\text{V}$			500	nA	
$Q_{G(on)}$	total gate charge	$V_{CE} = 600\text{V}; V_{GE} = 15\text{V}; I_C = 10\text{A}$		27		nC	
$t_{d(on)}$	turn-on delay time	inductive load $V_{CE} = 600\text{V}; I_C = 10\text{A}$ $V_{GE} = \pm 15\text{V}; R_G = 100\Omega$		70		ns	
$t_r$	current rise time		$T_{VJ} = 125^{\circ}\text{C}$	40		ns	
$t_{d(off)}$	turn-off delay time		250		ns		
$t_f$	current fall time		100		ns		
$E_{on}$	turn-on energy per pulse		1.1		mJ		
$E_{off}$	turn-off energy per pulse		1.1		mJ		
<b>RBSOA</b>	reverse bias safe operating area	$V_{GE} = \pm 15\text{V}; R_G = 100\Omega$					
$I_{CM}$		$V_{CEmax} = 1200\text{V}$			30	A	
<b>SCSOA</b>	short circuit safe operating area	$V_{CEmax} = 900\text{V}$					
$t_{sc}$	short circuit duration	$V_{CE} = 900\text{V}; V_{GE} = \pm 15\text{V}$			10	$\mu\text{s}$	
$I_{sc}$	short circuit current	$R_G = 100\Omega; \text{non-repetitive}$		40		A	
$R_{thJC}$	thermal resistance junction to case				1.5	K/W	
$R_{thCH}$	thermal resistance case to heatsink			0.25		K/W	
<b>Diode</b>							
$V_{RRM}$	max. repetitive reverse voltage	$T_{VJ} = 25^{\circ}\text{C}$			1200	V	
$I_{F25}$	forward current	$T_C = 25^{\circ}\text{C}$			22	A	
$I_{F100}$		$T_C = 100^{\circ}\text{C}$			14	A	
$V_F$	forward voltage	$I_F = 10\text{A}$			2.20	V	
				1.95		V	
$I_R$	reverse current	$V_R = V_{RRM}$			*	mA	
	* not applicable, see Ices value above				*	mA	
$Q_{rr}$	reverse recovery charge	$V_R = 600\text{V}$ $-di_F/dt = -250\text{A}/\mu\text{s}$ $I_F = 10\text{A}; V_{GE} = 0\text{V}$		1.3		$\mu\text{C}$	
$I_{RM}$	max. reverse recovery current		$T_{VJ} = 125^{\circ}\text{C}$	10.5		A	
$t_{rr}$	reverse recovery time		350		ns		
$E_{rec}$	reverse recovery energy		0.35		mJ		
$R_{thJC}$	thermal resistance junction to case				1.8	K/W	
$R_{thCH}$	thermal resistance case to heatsink			0.25		K/W	

preliminary

Package TO-247			Ratings			
Symbol	Definition	Conditions	min.	typ.	max.	Unit
$I_{RMS}$	RMS current	per terminal			70	A
$T_{VJ}$	virtual junction temperature		-40		150	°C
$T_{op}$	operation temperature		-40		125	°C
$T_{stg}$	storage temperature		-40		150	°C
<b>Weight</b>				6		g
$M_D$	mounting torque		0.8		1.2	Nm
$F_C$	mounting force with clip		20		120	N

### Product Marking

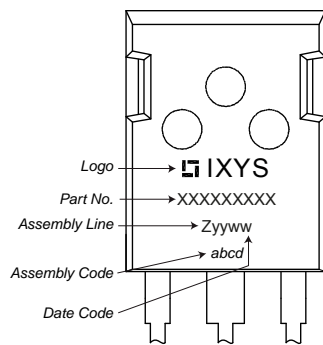

### Part number

- I = IGBT
- X = XPT IGBT
- A = Gen 1 / std
- 12 = Current Rating [A]
- IF = Copack
- 1200 = Reverse Voltage [V]
- HB = TO-247AD (3)

Ordering	Part Number	Marking on Product	Delivery Mode	Quantity	Code No.
Standard	IXA12IF1200HB	IXA12IF1200HB	Tube	30	508453

Similar Part	Package	Voltage class
IXA12IF1200PB	TO-220AB (3)	1200
IXA12IF1200TC	TO-268AA (D3Pak) (2)	1200

### Equivalent Circuits for Simulation

\* on die level

$T_{VJ} = 150\text{ °C}$

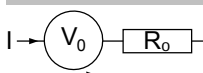

	IGBT	Diode	
$V_{0\ max}$ threshold voltage	1.1	1.25	V
$R_{0\ max}$ slope resistance *	153	85	mΩ

## Outlines TO-247

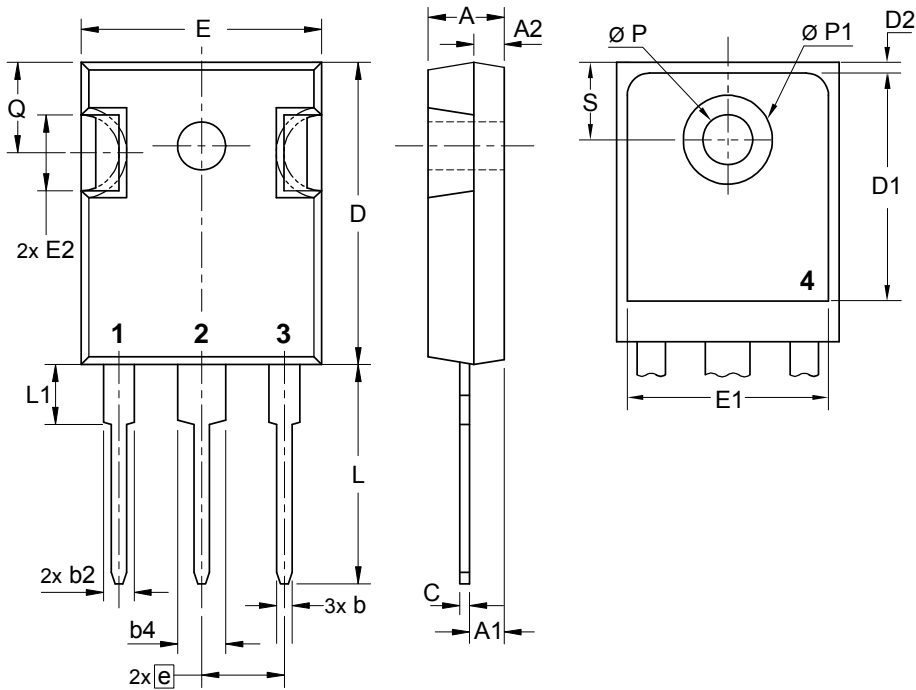

Sym.	Inches		Millimeter	
	min.	max.	min.	max.
A	0.185	0.209	4.70	5.30
A1	0.087	0.102	2.21	2.59
A2	0.059	0.098	1.50	2.49
D	0.819	0.845	20.79	21.45
E	0.610	0.640	15.48	16.24
E2	0.170	0.216	4.31	5.48
e	0.215 BSC		5.46 BSC	
L	0.780	0.800	19.80	20.30
L1	-	0.177	-	4.49
Ø P	0.140	0.144	3.55	3.65
Q	0.212	0.244	5.38	6.19
S	0.242 BSC		6.14 BSC	
b	0.039	0.055	0.99	1.40
b2	0.065	0.094	1.65	2.39
b4	0.102	0.135	2.59	3.43
c	0.015	0.035	0.38	0.89
D1	0.515	-	13.07	-
D2	0.020	0.053	0.51	1.35
E1	0.530	-	13.45	-
Ø P1	-	0.29	-	7.39

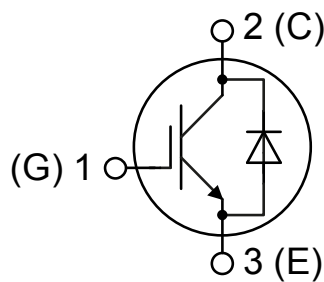

## IGBT

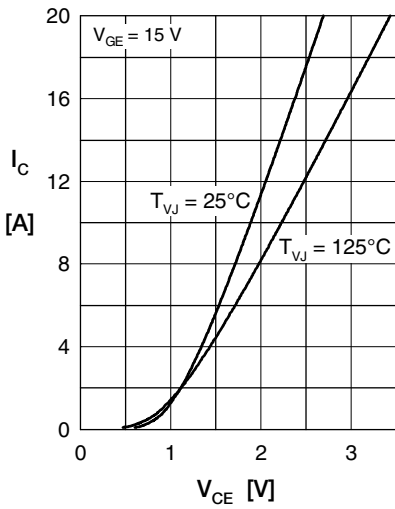

Fig. 1 Typ. output characteristics

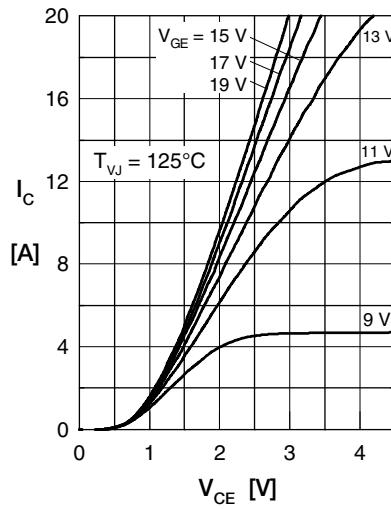

Fig. 2 Typ. output characteristics

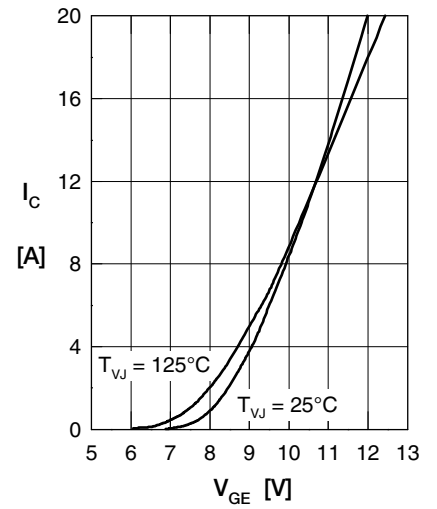

Fig. 3 Typ. transfer characteristics

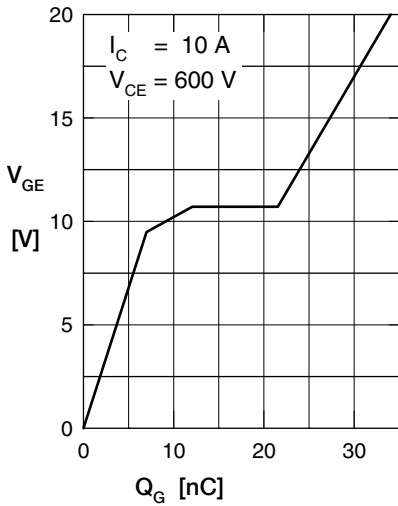

Fig. 4 Typ. turn-on gate charge

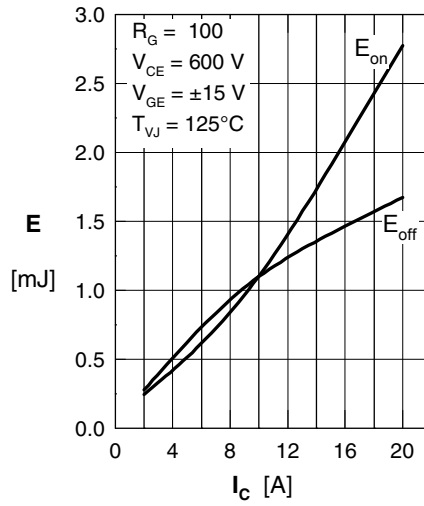

Fig. 5 Typ. switching energy vs. collector current

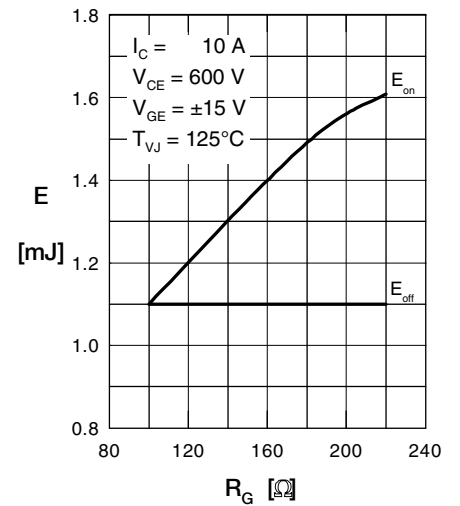

Fig. 6 Typ. switching energy vs. gate resistance

Fig. 7 Typ. transient thermal impedance junction to case

## Diode

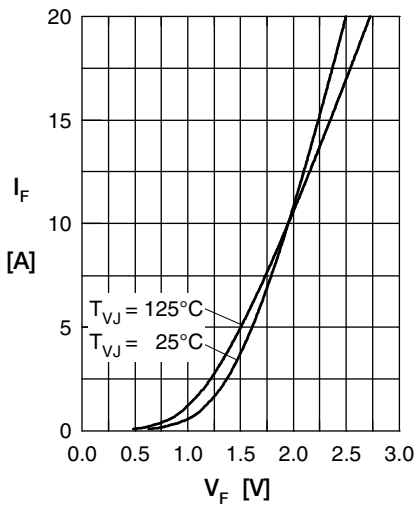

Fig. 1 Typ. forward current versus  $V_F$

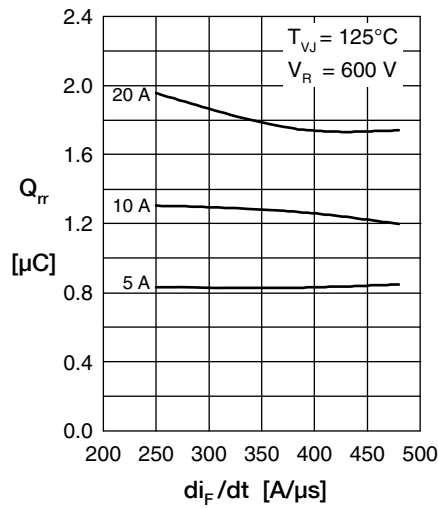

Fig. 2 Typical reverse recov. charge  $Q_{rr}$  versus  $di_F/dt$

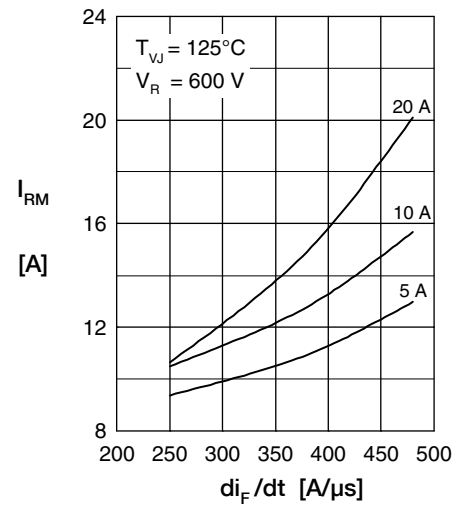

Fig. 3 Typ. peak reverse current  $I_{RM}$  versus  $di_F/dt$

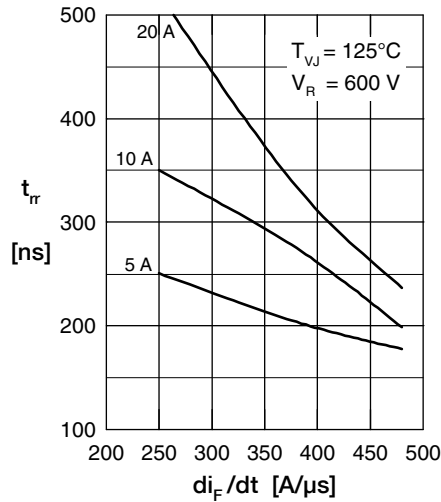

Fig. 4 Dynamic parameters  $Q_{rr}$ ,  $I_{RM}$  versus  $T_{VJ}$

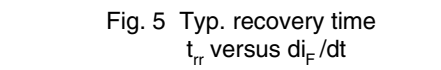

Fig. 5 Typ. recovery time  $t_{rr}$  versus  $di_F/dt$

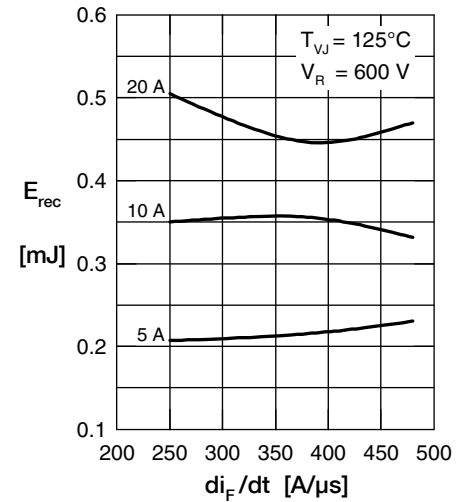

Fig. 6 Typ. recovery energy  $E_{rec}$  vs.  $di_F/dt$

Fig. 7 Typ. transient thermal impedance junction to case